



CATALOGUE  
2018-19



SAKAPÒSH - Piazza Madama Cristina, 6 - Torino  
Progetto Interni: Arch. Niccolo Piccini  
Lighting Plan: Arch. Dario Ravetto    Pag. 76 - 79





SAKAPÒSH - Piazza Madama Cristina, 6 - Torino  
Progetto Interni: Arch. Niccolò Piccini  
Lighting Plan: Arch. Dario Ravetto

Pag. 76 - 79





I Giardino degli Angeli - [ilgiardinodegliangeliassisi.it](http://ilgiardinodegliangeliassisi.it)  
Rivotorto - Assisi (Pg) Italy





I Giardino degli Angeli - [ilgiardinodegliangeliassisi.it](http://ilgiardinodegliangeliassisi.it)  
Rivotorto - Assisi (Pg) Italy

Pag. 132 - 133



Pag. 92 - 93





I Giardino degli Angeli - [ilgiardinodegliangeliassisi.it](http://ilgiardinodegliangeliassisi.it)  
Rivotorto - Assisi (Pg) Italy



Project: Mawa Pub - Lighting design: SIENERSYS d.o.o. Pag. 134 - 137  
Architects: Ivana Radic and Marko Conic - (Architectural studio: A-Sign)  
Photographer: Dusan Grubin







Project: Stara Przepompownia - Ostrow Wielkopolski, Poland  
Company: Miviena  
Designer: Mirosław Chudalewski









Project: Stara Przepompownia - Ostrow Wielkopolski, Poland  
Company: Miviena  
Designer: Mirosław Chudalewski





Pag. 138 - 139















Pag. 272 - 273











Project: Stara Przepompownia - Ostrow Wielkopolski, Poland  
Company: Miviena  
Designer: Mirosław Chudalewski





Project: Stara Przepompownia - Ostrow Wielkopolski, Poland  
Company: Miviena  
Designer: Mirosław Chudalewski





Pag. 114 - 115







Pag. 190 - 195



Fashion - Lumezzane - Italy Pag. 67

 Moretti Luce





Ristorante a Zlatar Bistrica - Croazia  
Realizzato da: **5M d.o.o.** e **LIV d.o.o.**







# Colori ottone

## Brass colors - Messing farbe

**.AR**

**CHIARIMENTI:** L'Antichizzazione è fatta manualmente e la tonalità dell'ottone può avere sfumature diverse da quelle delle foto.

Colore ottone antichizzato ramato per interni ed esterni

Aged brass copper-coloured for indoor and outdoor

Laiton vieilli cuivré pour intérieur et l'extérieur

Antikisierter messing für den innenraum und außenraum



**.NA**

Colore nickel antichizzato per interni

Old silver color for indoor

Antique nickel pour intérieur

Antike nickel farbe für den innenraum



**.BA**

**CHIARIMENTI:** L'Antichizzazione è fatta manualmente e la tonalità dell'ottone può avere sfumature diverse da quelle delle foto.

Colore ottone brunito antichizzato per interni ed esterni

Brass burnish finishing dark brown for indoor and outdoor

Laiton vieilli pour intérieur et l'extérieur

Antikisierter messing für den innenraum und außenraum



**.A**

Ottone brunito con vernice trasparente, colore adatto solo per interni

Brass burnish finishing with transparent vernish, only for indoor light

Laiton vieilli avec verni transparent, seulement pour mettre dedans les maisons

Antikisierter messing für den innenraum



**CHIARIMENTI:** L'Antichizzazione è fatta manualmente e la tonalità dell'ottone può avere sfumature diverse da quelle delle foto. L'Antichizzazione fatta a mano non impedisce la naturale ossidazione di questo metallo che, esposto all'esterno, è soggetto all'azione degli eventi naturali. I nostri prodotti non sono autopulenti quindi, se vengono ricoperti da salsedine, devono essere puliti con i normali prodotti per pulizia dei metalli. Svolta la procedura di pulitura, pian piano nel tempo riprodurranno la patina tipica dell'invecchiamento dell'ottone.

**.V** - Ottone lucido  
con vernice protettiva trasparente,  
colore adatto solo per interni  
Polished brass with transparent protection  
only for indoor light  
Laiton verni seulement pour mettre  
dedans les maisons



**.D** - Ottone bagno oro 24 Kt  
Laiton doré 24 carats  
Brass 24 Kt gold - dipped

**Esempio - Example**

**Art. 1506.V** = ottone lucido  
laiton verni - polished brass

**Art. 1506.A** = ottone brunito antichizzato  
laiton vieilli - brass burnish finishing

**Colore vetri**

**Couleurs des opalines - Glass colors - Gläs farbe**



**.6** - Bianco  
- Blanc - White - Weiss



**.7** - Ambra  
- Paille - Amber - Bernstein



**.8** - Verde  
- Vert - Green - Grün

**Esempio - Example**

**Art. 1924.A.8**= ottone brunito antichizzato con vetro verde  
laiton vieilli avec opaline vert  
brass burnish finishing with green glass



# News 2018



Pag. 34 - 37



Pag. 38



Pag. 39



Pag. 40



Pag. 68



Pag. 87



Pag. 72



Pag. 196 - 197



Pag. 50



Pag. 82 - 83



Pag. 88 - 89

# News 2018



Pag. 94 - 95



Pag. 92 - 93



Pag. 110



Pag. 111

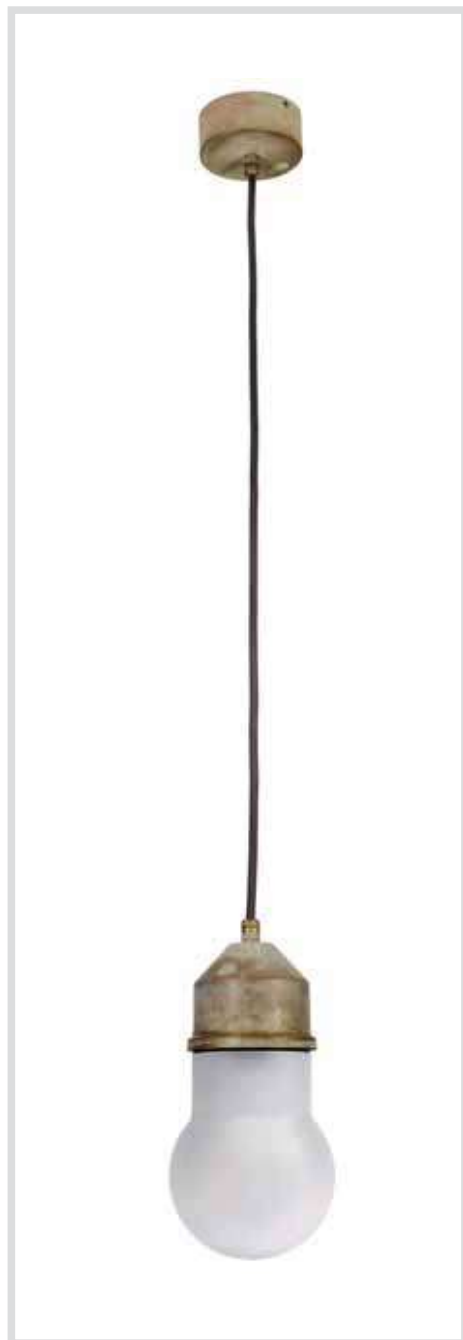



Pag. 112 - 113



Pag. 252 - 257



# Indice/Index

Art.	Pag.		Art.	Pag.
Colori Ottone - Brass Colors	24		1423	92
Vetri - Glass	25/298		1423F	93
V1 → V30			1425F → 1426F	95
Grado di protezione degli apparecchi	296/297		1440 → 1444	292
Appliance protection ratings			1448 - 1449 - 1452 - 1453	294
Legenda dei simboli			1460 → 1463	94
Key to symbols			1460F → 1463F	95
125.AR - 129.AR	180		1500 → 1503	290
133 - 134	178/179		1506 - 1507	284
139 - 140	178/179		1509 → 1511	288
161 → 164	178/179		1512 - 1513	286
180 → 184	196/197		1520	88
186 - 187 - 188	198/199		1521	92
200.09	190		1521F	93
200.10	194		1523	90
200.14 - 200.15	192/193		1526	91
200.20 - 200.21	200		1530F	93
203 - 204 - 205 - 206	191		1535 - 1536	91
216 - 217 - 218 - 219	195		1548 - 1549	92
809	186		1548F - 1549F	93
805P - 806P	188		1590 → 1595	132/133
993 - 994	186		1596	135
993P - 994P	188		1598 - 1600 → 1604	258/259
1005	264		1606	266
1006 - 1007	272		1607 - 1608	282
1008 → 1011	268		1615 - 1616	265/266
1018 → 1021	270		1620 → 1631	154/155
1050 - 1051	274		1625	266
1058 → 1062	278		1639 → 1648	260/263
1098 - 1100 - 1101 - 1112	280		1650 → 1660	164/165
1240 → 1246	276		1658R	166
1330 → 1335	162/163		1670 → 1679	134/135
1336	164		1690 → 1699	146/147
1340 → 1345	152/153		1697R	148
1346	155		1712	147
1350 → 1357	144/145		1720 → 1723	138/139
1360 → 1365	160/161		1730 → 1735	140
1411 - 1412	88		1736 → 1739	142/143
1411F → 1422F	88		1740 → 1743	106/107
1421 - 1422	89		1745 - 1746	104
			1750 → 1755	158/159
			1760 → 1765	150/151
			1770 → 1775	168/169

Art.	Pag.	Art.	Pag.
1780 → 1780R	134/137	3078	62
1790 → 1794	184/185	3079	62
1820 → 1823	108/109	3082	61
1840 - 1841	124	3083	60
1850 → 1855	114/115	3084	62
1856 → 1860	116/117	3085	65
1870 → 1877	120/121	3086	64
1880 - 1881	215/216	3087	60
1882 - 1883	217/218	3090 - 3091 - 3092	50
1884	213	3093	52
1885	223	3094	51
1886 - 1887	219/220	3095	50
1888 - 1889	221/222	3096	52
1890 → 1894	218/219	3097 - 3098 - 3099	54
1900 → 1907	122/123	3100	56
1950N → 1953N	110/113	3101	55
1962	125	3102	53
1970 → 1973	181	3104	54
2010	232	3105 - 3106	50
2011 - 2012	235/236	3120 → 3122 (ARVS)	80/81/83
2013	238	3120 → 3122 (AR - BA)	84/85
2014	228	3123 → 3128 (ARVS)	82/83/87
2015	248	3123 → 3128 (AR - BA)	86
2016 - 2017	241/242	3123T → 3127T	96
2018 - 2019	245/246	3128T	97
2020	212	3137T → 3142T	98
2023	214	3140 → 3142	98
2024	225	3147T - 3148T	97
2030	226	3196	52
2033	230	3200 → 3204 (AR - BA)	70
2034	249/251	3200 → 3204 (ARVS)	66
2050 → 2057	170/171	3235T → 3237T	79
2060 → 2066	172/173	3238 → 3240 (ARVS)	68
2070 → 2076	174/175	3238 → 3240 (AR - BA)	71
2080 → 2086	176/177	3238T → 3242T	78
2090 → 2095	182/183	3245 (ARVS)	68
3010 → 3018	202/203	3245	74
3020 → 3024	204/205	3246	74
3025 → 3028	206/209	3247	75
3070 - 3071 - 3072 - 3073	58	3248 (ARVS)	69
3074	58	3248 (AR - BA)	72/73
3075	62	3248R (ARVS)	68
3076	60	3248R (AR - BA)	71
		3249 (AR - BA)	74



# Indice/Index

---

Art.	Pag.
3272	48
3273 - 3274	43
3276	43
3280 - 3281	42
3282 - 3283 - 3284	44
3285 (ARVS)	46
3286 - 3287	42
3288	43
3289	45
3300 → 3303	126
3306 - 3307	126
3308 - 3309 - 3312	128
3310 - 3311	129
3313 → 3317	127
3330T - 3331T - 3332T	100
3333T - 3334T	100
3335T - 3336T - 3337T	101
3338T - 3339T - 3340T	102
3341T - 3342T	102
3350T - 3354T	130/131
4030 → 4035	252
4036	254/255
4088 → 4091	34
4092 → 4093	35
4094	36
4095	37
4096 → 4099	38/39
4100	40/41



# Sospensioni regolabili Adjustable suspensions

**New**



ART. 3085.AR



ART. 3285.AR.VS



ART. 3101.AR



ART. 3354.AR



ART. 3248.AR



regolazione altezza  
height adjustment



Moretti Luce



# Sospensioni regolabili

## Adjustable suspensions



Art. **1336.T.AR**  
(con vetro/with glass)

Art. **1336.AR**  
(senza vetro/without glass)



Art. **1354.T.AR**  
(con vetro/with glass)

Art. **1354.AR**  
(senza vetro/without glass)

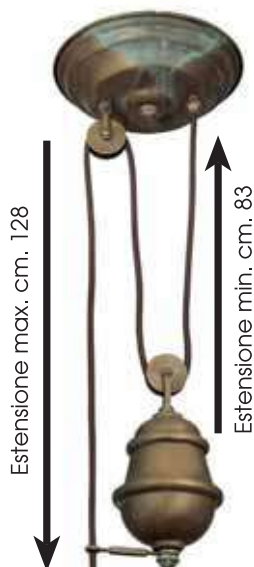

Art. **1596.T.AR**  
(con vetro/with glass)

Art. **1596.AR**  
(senza vetro/without glass)



Art. **1346.T.AR**  
(con vetro/with glass)

Art. **1346.AR**  
(senza vetro/without glass)

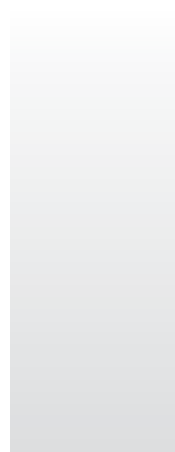

Estensione max. cm. 128

Estensione min. cm. 83

Finitura ottone  
Finition laiton  
Brass finishes

**.A.AR.BA**

**.AR.BA=**  
OTTONE ANTICIZZATO  
LAITON VIEILLI  
AGED BRASS  
ANTIKISIERTER MESSING

**non teme la salsedine**  
**chlorimenti a Pag. 265**  
**no salt corrosion**

Cavo tessuto  
Cable tisseu  
Câble tissu  
Kabel stoff

CE IP 20 - E 27

Max Watt 52



20/23 Watt



Moretti Luce



**New**



①



②



①

**ART. 4088.AR.VS**  
 H. 200 - Larg. 144

②

**ART. 4089.AR.VS**  
 H. 220 - Larg. 144

③

**ART. 4090.AR.VS**  
 H. 260 - Larg. 320

④

**ART. 4091.AR.VS**  
 H. 340 - Larg. 330



Ø 110

③



④



Colori ottone/Couleurs laiton/Brass colors/Messing farbe

**.AR**



**.BA**



**.S**



ES: Art. 4088.S

OTTONE ANTICIZZATO  
 AGED BRASS / LAITON VIEILLI / ANTIKISIERTER MESSING

**New**



①



②



③

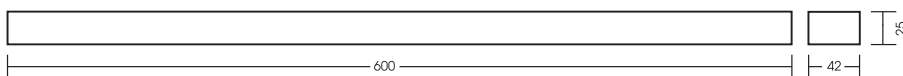
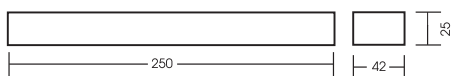

①

ART. 4092R.AR.VS  
 H. 190 - Larg. 240

②

ART. 4092q.AR.VS  
 H. 145 - Larg. 130

③

ART. 4093.AR.VS  
 H. 145 - Larg. 700



Colori ottone/Couleurs laiton/Brass colors/Messing farbe

.AR



.BA



.S



ES: Art. 4092R.S

CE IP 20 - E 27  
 INDOOR LIGHTING

Max Watt 28



LED bulb  
 lampadina a LED - Ø 45 - H. 73

lampadina non inclusa / bulbs not included

CLASSE EFFICIENZA  
 ENERGETICA A+ ÷ E  
 energy efficiency classes





ART. 4094.AR.VS  
H. 1770 - Larg. 470



Colori ottone  
Couleurs laiton/Brass colors/Messing farbe

.AR



.BA



.S



CE IP 20 - E 27  
INDOOR LIGHTING

Max Watt 28



LED bulb  
lampadina a LED - Ø 50 - H. 73

lampadina non inclusa / bulbs not included

CLASSE EFFICIENZA  
ENERGETICA A+ ÷ E  
energy efficiency classes

OTTONE ANTICIZZATO  
AGED BRASS / LAITON VIEILLI / ANTIKISIERTER MESSING

**New**



regolazione altezza  
hight adjustment



**ART. 4095.5LAR.VS**  
cavo / cable mm 1500  
Max Watt 5 x 28



**New**

A RICHIESTA: cavo con lunghezza personalizzata e con più luci  
ON REQUEST: custom cable length or with more lights

4095.6L 4095.7L 4095.8L 4095.9L 4095.10L



Per 6 e più punti luce  
For 6 light and more



# New

OTTONE ANTICIZZATO  
AGED BRASS / LAITON VIEILLI / ANTIKISIERTER MESSING

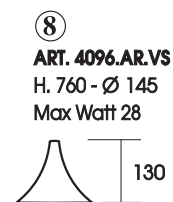
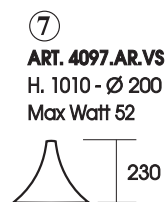
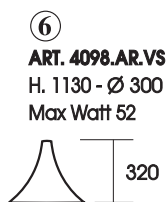
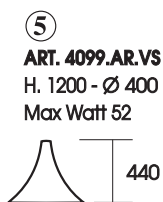

# New

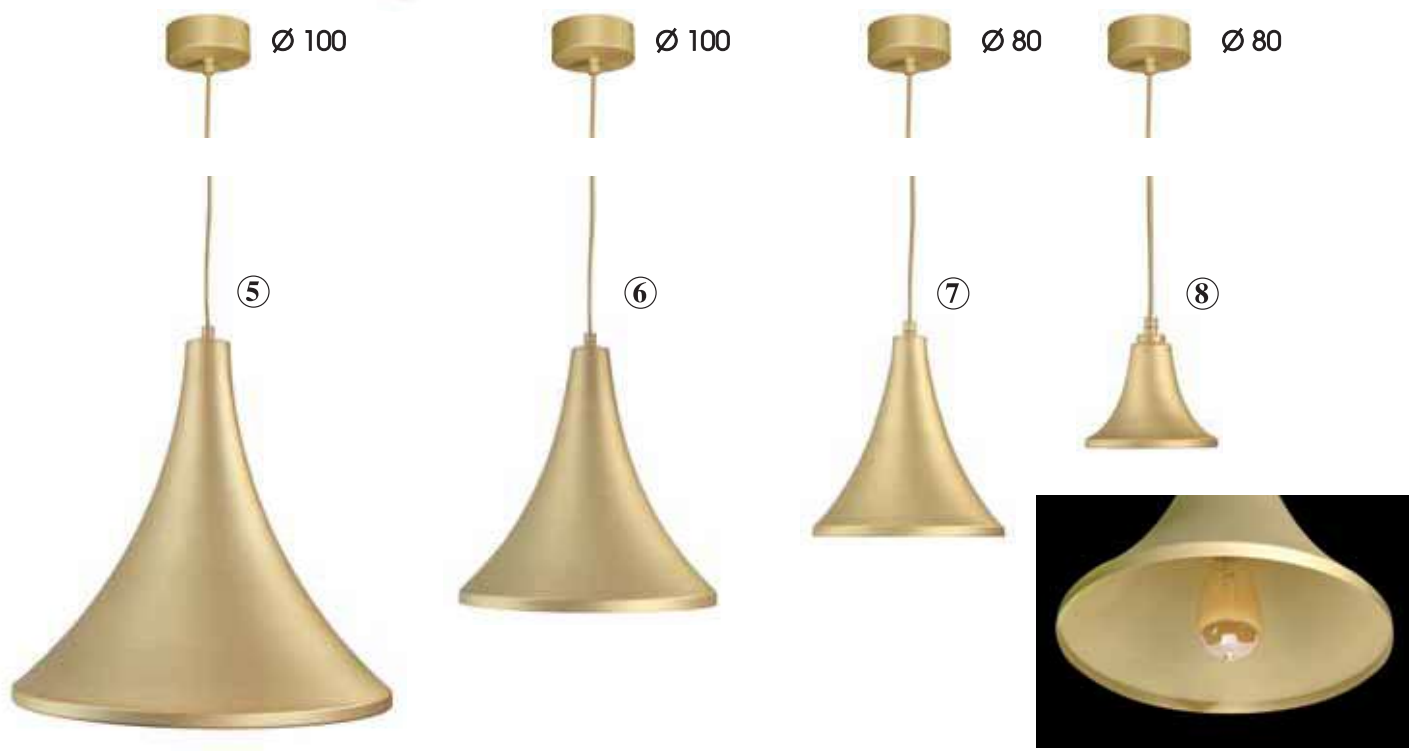

⑤ ⑥



Ø 64 - H. 145

⑦



LED bulb  
lampadina a LED  
lampadina non inclusa  
bulbs not included

⑤

**ART. 4099.S**  
H. 1200 - Ø 420  
Max Watt 52

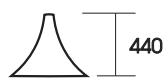

⑥

**ART. 4098.S**  
H. 1130 - Ø 300  
Max Watt 52

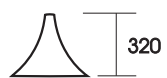

⑦

**ART. 4097.S**  
H. 1010 - Ø 210  
Max Watt 52



⑧

**ART. 4096.S**  
H. 760 - Ø 140  
Max Watt 28

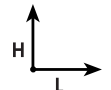



**New**

ART. 4100.S  
Ø 210



Colori ottone/Couleurs laiton/Brass colors/Messing farbe

.AR



.BA



.S



.AR.BA= OTTONE ANTICIZZATO / AGED BRASS / LAITON VIEILLI / ANTIKISIERTER MESSING

CE IP 20 - E 27  
INDOOR LIGHTING

Max Watt 52



Ø 64 - H. 145



LED bulb  
lampadina a LED  
lampadina non inclusa  
bulbs not included

CLASSE EFFICIENZA  
ENERGETICA A+ ÷ E  
energy efficiency classes

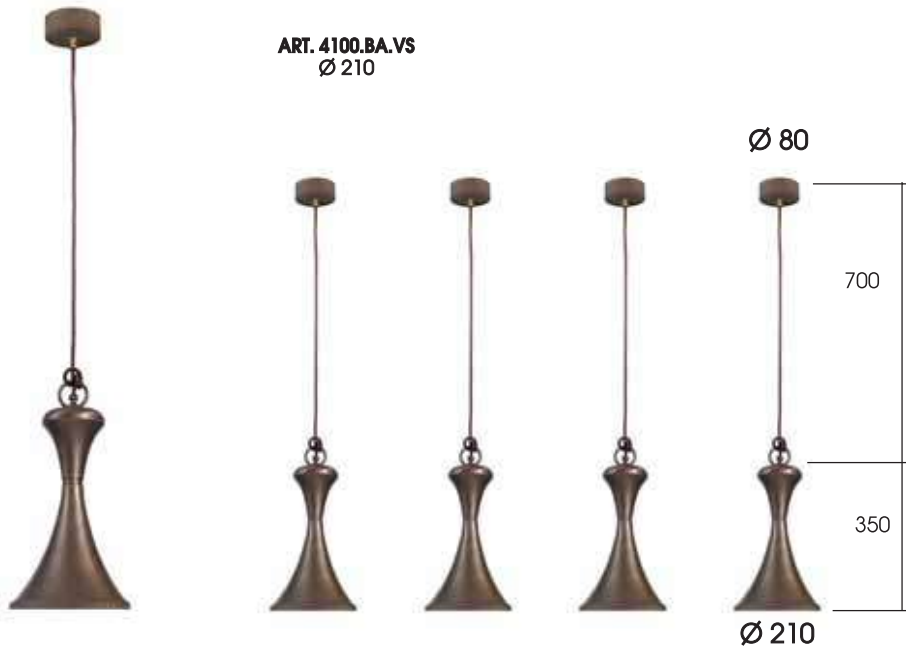

**New**



**New**





OTTONE ANTICIZZATO  
 AGED BRASS / LAITON VIEILLI / ANTIKISIERTER MESSING

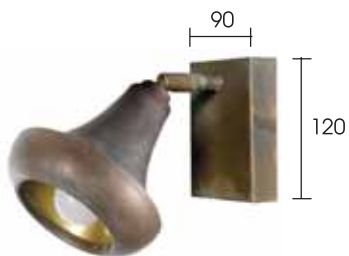

①  
**ART. 3281.AR.VS**  
 H. 200 - Larg. 144

②  
**ART. 3280.AR.VS**  
 H. 220 - Larg. 144

③  
**ART. 3286.AR.VS**  
 H. 260 - Larg. 320

④  
**ART. 3287.AR.VS**  
 H. 340 - Larg. 330



Colori ottone/Couleurs laiton/Brass colors/Messing farbe

**.AR**



**.BA**



**.NA**



**.AR.BA.NA= OTTONE ANTICIZZATO / AGED BRASS / LAITON VIEILLI / ANTIKISIERTER MESSING**  
**.NA non per art. / not for art. 3274 - 3275 - 3276 - 3278 - 3288**

**CE** IP 20 - E 27  
 INDOOR LIGHTING



Max Watt 28



LED bulb  
 lampadina a LED

Beghelli Ø 45 - H. 73 - ECOLED 6 W ① ② ③ ④ ⑧  
 lampadina non inclusa / bulbs not included

**CLASSE EFFICIENZA ENERGETICA A+ ÷ E**  
 energy efficiency classes



⑤ ⑥



Ø 64 - H. 145

⑦



LED bulb  
 lampadina a LED

lampadina non inclusa  
 bulbs not included

⑤

**ART. 3288.AR.VS**  
 H. 1200 - Ø 400  
 Max Watt 52



⑥

**ART. 3276.AR.VS**  
 H. 1130 - Ø 300  
 Max Watt 52



⑦

**ART. 3274.AR.VS**  
 H. 1010 - Ø 200  
 Max Watt 52



⑧

**ART. 3273.AR.VS**  
 H. 760 - Ø 145  
 Max Watt 28

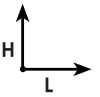



OTTONE ANTICIZZATO  
 AGED BRASS / LAITON VIEILLI / ANTIKISIERTER MESSING



①



②



③



①

ART. 3283.AR.VS  
 H. 190 - Larg. 240

②

ART. 3282.AR.VS  
 H. 145 - Larg. 130

③

ART. 3284.AR.VS  
 H. 145 - Larg. 700

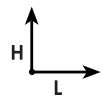

Colori ottone/Couleurs laiton/Brass colors/Messing farbe

.AR



.BA



.NA



.AR.BA.NA= OTTONE ANTICIZZATO / AGED BRASS / LAITON VIEILLI / ANTIKISIERTER MESSING

CE IP 20 - E 27  
 INDOOR LIGHTING

Max Watt 28



LED bulb  
 Lampadina a LED

Beghelli Ø 45 - H. 73 - ECOLED 6 W  
 lampadina non inclusa / bulbs not included

CLASSE EFFICIENZA  
 ENERGETICA A+ ÷ E  
 energy efficiency classes

OTTONE ANTICIZZATO  
AGED BRASS / LAITON VIEILLI / ANTIKISIERTER MESSING



ART. 3289.AR.VS  
H. 1770 - Larg. 470



Colori ottone  
Couleurs laiton/Brass colors/Messing farbe

.AR



.BA



.NA



.AR.BA.NA= OTTONE ANTICIZZATO  
AGED BRASS / LAITON VIEILLI / ANTIKISIERTER MESSING

CE IP 20 - E 27  
INDOOR LIGHTING

Max Watt 28



LED bulb  
lampadina a LED

Beghelli Ø 45 - H. 73 - ECOLED 6 W  
lampadina non inclusa / bulbs not included

CLASSE EFFICIENZA  
ENERGETICA A+ ÷ E  
energy efficiency classes

OTTONE ANTICIZZATO  
AGED BRASS / LAITON VIEILLI / ANTIKISIERTER MESSING



regolazione altezza  
hight adjustment



ART. 3285.AR.VS  
cavo / cable mm 1500  
Max Watt 5 x 28



**New**

A RICHIESTA: cavo con lunghezza personalizzata e con più luci  
ON REQUEST: custom cable length or with more lights

3285.3L	3285.6L	3285.8L	3285.10L	3285.12L	3285.14L
3285.4L	3285.7L	3285.9L	3285.11L	3285.13L	3285.15L





ART. 3270.AR.VS

**New**



Colori ottone/Couleurs laiton/Brass colors/Messing farbe

.AR

.BA



.AR.BA= OTTONE ANTICHIZZATO / AGED BRASS / LAITON VIEILLI / ANTIKISIERTER MESSING

CE IP 20 - E 27  
 INDOOR LIGHTING

Max Watt 52

Ø 64 - H. 145

LED bulb  
 lampadina a LED  
 lampadina non inclusa  
 bulbs not included

CLASSE EFFICIENZA  
 ENERGETICA A+ ÷ E  
 energy efficiency classes



ART. 3272.AR.VS



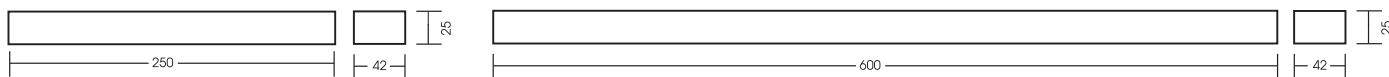

Dimensioni senza lampadina / Sizes without bulb  
**Max Watt 28**

OTTONE ANTICIZZATO  
 AGED BRASS / LAITON VIEILLI / ANTIKISIERTER MESSING



**ART. 3094.AR**  
 H. 120 - Larg. 80 - Max Watt 28



Colori ottone/Couleurs laiton/Brass colors/Messing farbe



**.AR.BA.NA**= OTTONE ANTICIZZATO / AGED BRASS / LAITON VIEILLI / ANTIKISIERTER MESSING

**CE** IP 20 - E 27  
 INDOOR LIGHTING

Max Watt 28\*



Ø 64 - H. 145  
 Toledo Retro - ST 64 - 4 W Sylvania



LED bulb  
 lampadina a LED  
 lampadina non inclusa  
 bulbs not included

**CLASSE EFFICIENZA  
 ENERGETICA A+ ÷ E**  
 energy efficiency classes

\*Max Watt 28: su superfici combustibili (legno ecc.): solo con lampadina con bulbo Ø 126 mm / On flammable surfaces (wood ec.) only with bulb Ø 126 mm -

Sono consigliate lampadine Led Max Watt 10 / Led bulb are recommended Max Watt 10

Max Watt 52: su superfici non combustibili



pag. 320 / Max Watt 52 see page 296



OTTONE ANTICIZZATO  
AGED BRASS / LAITON VIEILLI / ANTIKISIERTER MESSING



**ART. 3093.AR**  
H. 135 - base Larg. 600  
Max Watt 28



Ø 90

**ART. 3096.AR FLEX**  
H. 120 - Larg. 320  
Max Watt 28



**ART. 3196.AR FLEX**  
H. 200 - Larg. 460  
Max Watt 28

Colori ottone/Couleurs laiton/Brass colors/Messing farbe

.AR

.BA

.NA



.AR.BA.NA= OTTONE ANTICIZZATO / AGED BRASS / LAITON VIEILLI / ANTIKISIERTER MESSING

CE IP 20 - E 27  
INDOOR LIGHTING

Max Watt 28\*



Ø 64 - H. 145  
Toledo Retro - ST 64 - 4 W Sylvania



LED bulb  
lampadina a LED  
lampadina non inclusa  
bulbs not included

CLASSE EFFICIENZA  
ENERGETICA A+ ÷ E  
energy efficiency classes

\*Max Watt 28: su superfici combustibili (legno ecc.) solo con lampadina con bulbo Ø 126 mm / On flammable surfaces (wood ec.) only with bulb Ø 126 mm -



Sono consigliate lampadine Led Max Watt 10 / Led bulb are recommended Max Watt 10

Max Watt 52: su superfici non combustibili pag. 320 / Max Watt 52 see page 296







Ø 85

OTTONE ANTICIZZATO  
AGED BRASS / LAITON VIEILLI / ANTIKISIERTER MESSING



600

80

**ART. 3102.AR**  
H. 800 - Max Watt 52





**ART. 3097.AR FLEX**  
 H. 120 - Larg. 300

Max Watt 28



**ART. 3104.AR FLEX**  
 H. 390 - Larg. 120



**ART. 3098.AR FLEX**  
 H. 390 - Base Larg. 250



**ART. 3099.AR FLEX**  
 H. 390 - Base Larg. 600

Max Watt 28

Colori ottone/Couleurs laiton/Brass colors/Messing farbe

.AR

.BA

.NA



.AR.BA.NA= OTTONE ANTICIZZATO / AGED BRASS / LAITON VIEILLI / ANTIKISIERTER MESSING

**CE** IP 20 - E 27  
 INDOOR LIGHTING

Max Watt 28\*



Ø 64 - H. 145  
 Toledo Retro - ST 64 - 4 W Sylvania



LED bulb  
 lampadina a LED  
 lampadina non inclusa  
 bulbs not included

**CLASSE EFFICIENZA  
 ENERGETICA A+ ÷ E**  
 energy efficiency classes

\*Max Watt 28: su superfici combustibili (legno ecc.) solo con lampadina con bulbo Ø 126 mm / On flammable surfaces (wood ec.) only with bulb Ø 126 mm -

Sono consigliate lampadine Led Max Watt 10 / Led bulb are recommended Max Watt 10

Max Watt 52: su superfici non combustibili pag. 320 / Max Watt 52 see page 296



OTTONE ANTICIZZATO  
AGED BRASS / LAITON VIEILLI / ANTIKISIERTER MESSING

**New**

Art. RM1942

Ø 30

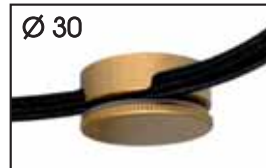

regolazione altezza incluso  
height adjustment included



ART. 3101.AR  
cavo / cable 1500  
Max Watt 5 x 52



Ø 310



Per 6 e più punti luce  
For 6 light and more

A RICHIESTA: cavo con lunghezza personalizzata e con più luci  
ON REQUEST: custom cable length or with more lights

3101.3L 3101.6L 3101.8L 3101.10L 3101.12L 3101.14L  
3101.4L 3101.7L 3101.9L 3101.11L 3101.13L 3101.15L





**ART. 3100.AR FLEX**  
H. 1600/1850 - Larg. 500  
Max Watt 3 x 52

Ø 260





OTTONE ANTICIZZATO  
AGED BRASS / LAITON VIEILLI / ANTIKISIERTER MESSING



**ART. 3070.AR**  
H. 160 - Larg. 110

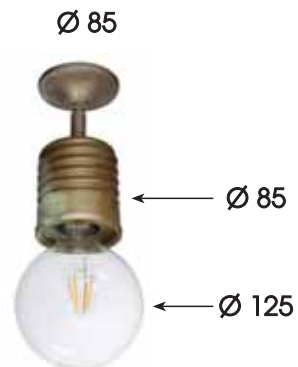

**ART. 3071.AR**  
H. 180 - Larg. 165  
Max Watt 52



**ART. 3072.AR**  
H. 116 - Larg. 190



**ART. 3073.AR**  
H. 175 - Larg. 640



Max Watt 28



OTTONE ANTICIZZATO  
 AGED BRASS / LAITON VIEILLI / ANTIKISIERTER MESSING



ART. 3074.AR  
 H. 138 - Larg. 90



Colori ottone/Couleurs laiton/Brass colors/Messing farbe



.AR.BA.NA= OTTONE ANTICIZZATO / AGED BRASS / LAITON VIEILLI / ANTIKISIERTER MESSING

CE IP 20 - E 27  
 INDOOR LIGHTING

Max Watt 28\*



Ø 64 - H. 145  
 Toledo Retro - ST 64 - 4 W Sylvania



LED bulb  
 lampadina a LED  
 lampadina non inclusa  
 bulbs not included

CLASSE EFFICIENZA  
 ENERGETICA A+ ÷ E  
 energy efficiency classes

\*Max Watt 28: su superfici combustibili (legno ecc.) solo con lampadina con bulbo Ø 126 mm / On flammable surfaces (wood ec.) only with bulb Ø 126 mm -

Sono consigliate lampadine Led Max Watt 10 / Led bulb are recommended Max Watt 10

Max Watt 52: su superfici non combustibili pag. 320 / Max Watt 52 see page 296



OTTONE ANTICIZZATO  
 AGED BRASS / LAITON VIEILLI  
 ANTIKISIERTER MESSING



**ART. 3076.AR FLEX**  
 H. 160 - Larg. 340  
 Max Watt 28



**ART. 3087.AR FLEX**  
 H. 124 - Larg. 300  
 Max Watt 28



**ART. 3083.AR FLEX**  
 H. 160 - Larg. 370  
 Max Watt 28

Colori ottone/Couleurs laiton/Brass colors/Messing farbe

**.AR**



**.BA**



**.NA**



**.AR.BA.NA= OTTONE ANTICIZZATO / AGED BRASS / LAITON VIEILLI / ANTIKISIERTER MESSING**

**CE** IP 20 - E 27  
 INDOOR LIGHTING

Max Watt 28\*



Ø 64 - H. 145  
**Toledo Retro - ST 64 - 4 W Sylvania**



LED bulb  
 lampadina a LED  
 lampadina non inclusa  
 bulbs not included

**CLASSE EFFICIENZA ENERGETICA A+ ÷ E**  
 energy efficiency classes

\*Max Watt 28: su superfici combustibili (legno ecc.) solo con lampadina con bulbo Ø 126 mm / On flammable surfaces (wood ec.) only with bulb Ø 126 mm -

Sono consigliate lampadine Led Max Watt 10 / Led bulb are recommended Max Watt 10

Max Watt 52: su superfici non combustibili



pag. 320 / Max Watt 52 see page 296



OTTONE ANTICIZZATO  
AGED BRASS / LAITON VIEILLI  
ANTIKISIERTER MESSING



**ART. 3082.NA**  
H. 710 - Larg. 83

Max Watt 52

**ART. 3082.AR**  
H. 710 - Larg. 83







**ART. 3075.AR**  
 H. 160 - Larg. 320  
 Max Watt 53



**ART. 3078.AR FLEX**  
 H. 430 - Base Larg. 120  
 Max Watt 28



**ART. 3084.AR FLEX**  
 H. 430 - Base Larg. 250



**ART. 3079.AR FLEX**  
 H. 430 - Base Larg. 600

Max Watt 28

Colori ottone/Couleurs laiton/Brass colors/Messing farbe

**.AR**



**.BA**



**.NA**



**.AR.BA.NA=** OTTONE ANTICHIZZATO / AGED BRASS / LAITON VIEILLI / ANTIKISIERTER MESSING

**CE** IP 20 - E 27  
 INDOOR LIGHTING

Max Watt 28\*



Ø 64 - H. 145  
 Toledo Retro - ST 64 - 4 W Sylvania



LED bulb  
 lampadina a LED  
 lampadina non inclusa  
 bulbs not included

**CLASSE EFFICIENZA  
 ENERGETICA A+ ÷ E**  
 energy efficiency classes

\*Max Watt 28: su superfici combustibili (legno ecc.) solo con lampadina con bulbo Ø 126 mm / On flammable surfaces (wood ec.) only with bulb Ø 126 mm -



Sono consigliate lampadine Led Max Watt 10 / Led bulb are recommended Max Watt 10

Max Watt 52: su superfici non combustibili



pag. 320 / Max Watt 52 see page 296





OTTONE ANTICHIZZATO  
AGED BRASS / LAITON VIEILLI / ANTIKISIERTER MESSING



**ART. 3086.BA**  
H. 1620/1900 - Larg. 670  
Max Watt 3 x 52





OTTONE ANTICIZZATO  
 AGED BRASS / LAITON VIEILLI / ANTIKISIERTER MESSING

Art. RM1942

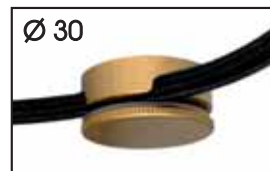

regolazione altezza incluso  
 height adjustment included

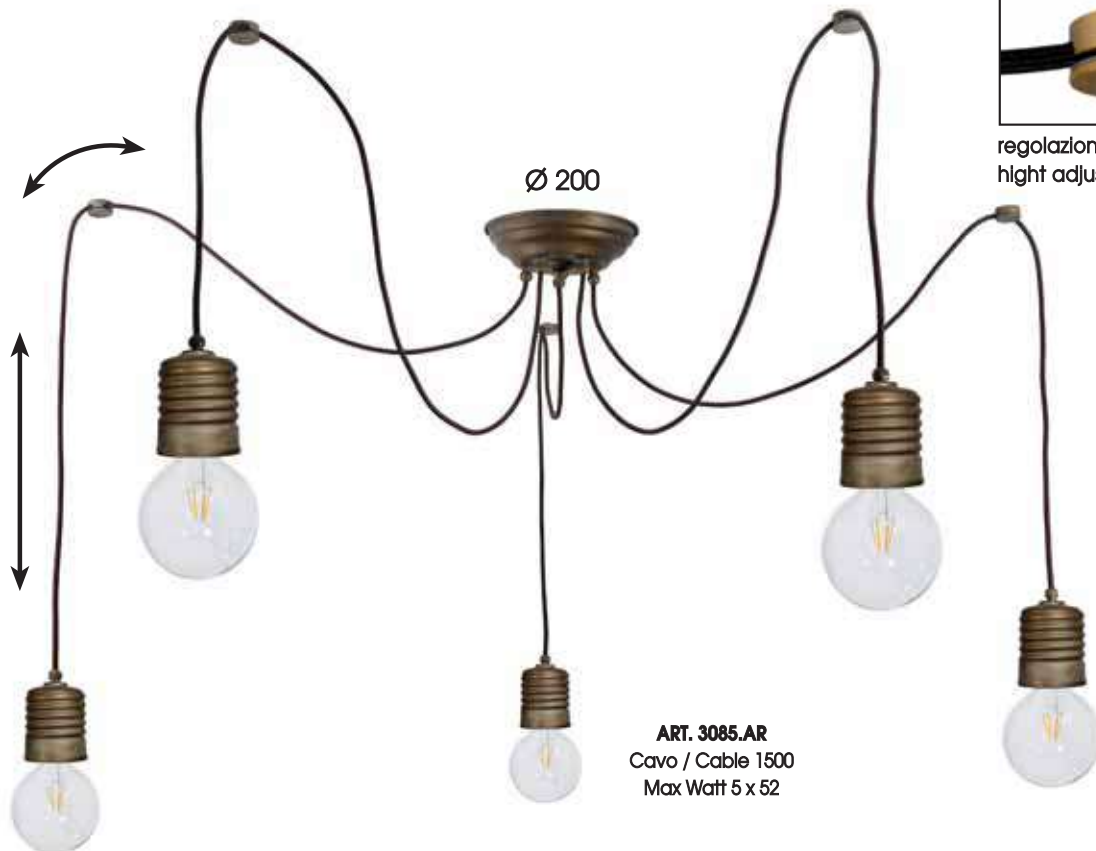

**ART. 3085.AR**  
 Cavo / Cable 1500  
 Max Watt 5 x 52



Per 6 e più punti luce  
 For 6 light and more

A RICHIESTA: cavo con lunghezza personalizzata e con più luci  
 ON REQUEST: custom cable length or with more lights

<b>3085.3L</b>	<b>3085.6L</b>	<b>3085.8L</b>	<b>3085.10L</b>	<b>3085.12L</b>	<b>3085.14L</b>
<b>3085.4L</b>	<b>3085.7L</b>	<b>3085.9L</b>	<b>3085.11L</b>	<b>3085.13L</b>	<b>3085.15L</b>

OTTONE ANTICIZZATO  
AGED BRASS / LAITON VIEILLI / ANTIKISIERTER MESSING



Colori ottone: superficie esterna del cappello  
Brass colors: outer surface of the hat



**.AR.BA= OTTONE ANTICIZZATO**  
AGED BRASS / LAITON VIEILLI / ANTIKISIERTER MESSING

Colori ottone: superficie interna del cappello  
Brass colors: inner surface of the hat



**.VS**

3203.AR.VS

ottone satinato protetto con vernice trasparente  
brass polished with transparent protection

esempio  
example:

**CE** IP 20 - E 27  
INDOOR LIGHTING

 Max Watt 52



LED bulb  
lampadina a LED

lampadina non inclusa / bulbs not included

**CLASSE EFFICIENZA  
ENERGETICA** A+ ÷ E  
energy efficiency classes

OTTONE ANTICIZZATO  
AGED BRASS / LAITON VIEILLI / ANTIKISIERTER MESSING



**ART. 3204.BA.VS**  
H. 1000 - Ø 500



**ART. 3204.AR.VS**  
H. 1000 - Ø 500





Ø 110



①



②



③



①

**ART. 3238.AR.VS**  
 H. 300 - Larg. 490

②

**ART. 3240.AR.VS**  
 H. 359 - Larg. 616

③

**ART. 3239.AR.VS**  
 H. 310 - Larg. 310

④

**ART. 3245.AR.VS**  
 H. 321 - Ø 250

⑤

**ART. 3248.AR.VS**  
 H. 643 - Ø 250



**.VS**

3203.AR.VS

ottone satinato protetto con vernice trasparente  
 brass polished with transparent protection

Colori ottone: superficie esterna del cappello  
 Brass colors: outer surface of the hat

**.AR**



**.BA**



**.AR.BA= OTTONE ANTICIZZATO**

AGED BRASS / LAITON VIEILLI / ANTIKISIERTER MESSING

**non teme la salsedine / no problem with salt corrosion**

**CE** IP 20 - E 27  
 INDOOR LIGHTING

Max Watt 52



LED bulb  
 Lampadina a LED

lampadina non inclusa / bulbs not included

**CLASSE EFFICIENZA  
 ENERGETICA A+ ÷ E**  
 energy efficiency classes

OTTONE ANTICIZZATO  
AGED BRASS / LAITON VIEILLI / ANTIKISERTER MESSING

Art. RM1942



regolazione altezza incluso  
hight adjustement included



ART. 3248.5L.AR.VS



**New**

A RICHIESTA: cavo con lunghezza personalizzata e con più luci  
ON REQUEST: custom cable length or with more lights

3248.2L.AR.VS - 3248.4L.AR.VS - 3248.6L.AR.VS - 3248.7L.AR.VS  
3248.8L.AR.VS - 3248.9L.AR.VS - 3248.10L.AR.VS



Per 6 e più punti luce  
For 6 light and more

OTTONE ANTICHIZZATO  
AGED BRASS / LAITON VIEILLI / ANTIKISIERTER MESSING

Ø 110



Colori ottone: superficie esterna del cappello  
Brass colors: outer surface of the hat



**.AR.BA= OTTONE ANTICHIZZATO**  
AGED BRASS / LAITON VIEILLI / ANTIKISIERTER MESSING

Colori ottone: superficie interna del cappello  
Brass colors: inner surface of the hat



**.AR**  
3203.AR

esempio  
example:

**CE** IP 20 - E 27  
INDOOR LIGHTING

 Max Watt 52



lampadina non inclusa / bulbs not included

**CLASSE EFFICIENZA  
ENERGETICA** A+ ÷ E  
energy efficiency classes



Ø 110



①



②



③

**New**



④



⑤

①

**ART. 3238.AR**  
 H. 300 - Larg. 490

②

**ART. 3240.AR**  
 H. 359 - Larg. 616

③

**ART. 3239.AR**  
 H. 310 - Larg. 310

④

**ART. 3245.AR**  
 H. 321 - Ø 250

⑤

**ART. 3248R.AR**  
 H. 643 - Ø 250

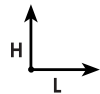

**.AR**

3203.AR

Colori ottone: superficie esterna del cappello  
 Brass colors: outer surface of the hat

**.AR**



**.BA**



**.AR.BA= OTTONE ANTICIZZATO**

AGED BRASS / LAITON VIEILLI / ANTIKISIERTER MESSING

**non teme la salsedine / no problem with salt corrosion**

**CE** IP 20 - E 27  
 INDOOR LIGHTING

Max Watt 52



LED bulb  
 Lampadina a LED

lampadina non inclusa / bulbs not included

**CLASSE EFFICIENZA  
 ENERGETICA A+ ÷ E**  
 energy efficiency classes

OTTONE ANTICIZZATO  
AGED BRASS / LAITON VIEILLI / ANTIKISERTER MESSING

Art. RM1942

Ø 30

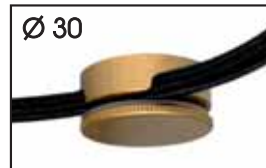

regolazione altezza incluso  
height adjustment included

**New**



ART. 3248.3LAR



ART. 3248.4LAR

Ø 310



Per 6 e più punti luce  
For 6 light and more

A RICHIESTA: cavo con lunghezza personalizzata e con più luci  
ON REQUEST: custom cable length or with more lights

3248.2LAR - 3248.4LAR - 3248.6LAR - 3248.7LAR - 3248.8LAR - 3248.9LAR - 3248.10LAR

OTTONE ANTICIZZATO  
AGED BRASS / LAITON VIEILLI / ANTIKISIERTER MESSING



regolazione altezza  
hight adjustement



**ART. 3248.5LAR**  
cavo / cable mm 1500  
Max Watt 5 x 52







①  
**ART. 3245.T.AR**  
 H. 213 - Larg. 250

③  
**ART. 3249.T.AR**  
 H. max 1200 min 740  
 Ø 250

④  
**ART. 3249.AR**  
 H. max 1180 min 738  
 Ø 250

⑤  
**ART. 3246.T.AR**  
 H. max 1290 min 790  
 Larg. 1000

⑥  
**ART. 3246.AR**  
 H. max 1288 min 792  
 Larg. 1000



Colori ottone: superficie esterna del cappello  
 Brass colors: outer surface of the hat

.AR

.BA



**.AR.BA= OTTONE ANTICIZZATO**  
 AGED BRASS / LAITON VIEILLI / ANTIKISIERTER MESSING





⑦



⑧

⑦  
**ART. 3247.AR**  
 H. max 1240 min 810  
 Larg. 1300

⑧  
**ART. 3247.T.AR**  
 H. max 1242 min 812  
 Larg. 1300

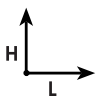









Ø 110



①



②



③



④



⑤

①

ART. 3238.T.AR  
H. 300 - Larg. 490

②

ART. 3240.T.AR  
H. 359 - Larg. 616

③

ART. 3239.T.AR  
H. 310 - Larg. 310

④

ART. 3241.T.AR  
H. 321 - Ø 250

⑤

ART. 3242.T.AR  
H. 643 - Ø 250



Colori ottone: superficie esterna del cappello  
Brass colors: outer surface of the hat

.AR



.BA



**.AR.BA= OTTONE ANTICHIZZATO**  
AGED BRASS / LAITON VIEILLI / ANTIKISIERTER MESSING  
**non teme la salsedine / no problem with salt corrosion**

CE IP 44 - E 27  
OUTDOOR

Max Watt 52



LED bulb  
lampadina a LED

lampadina non inclusa / bulbs not included

CLASSE EFFICIENZA  
ENERGETICA A+ ÷ E  
energy efficiency classes

OTTONE ANTICIZZATO  
AGED BRASS / LAITON VIEILLI / ANTIKISIERTER MESSING

OUTDOOR

Ø 110



**ART. 3235.T.AR**  
H. 900 - Ø 250



**ART. 3236.T.AR**  
H. 900 - Ø 300



**ART. 3237.T.AR**  
H. 1000 - Ø 500





OTTONE ANTICHIZZATO  
AGED BRASS / LAITON VIEILLI / ANTIKISIERTER MESSING

Ø 110



**ART. 3120.AR.VS**  
H. 900 - Ø 320



**ART. 3121.AR.VS**  
H. 1000 - Ø 400



**ART. 3122.AR.VS**  
H. 1000 - Ø 500

Colori ottone: superficie esterna del cappello  
Brass colors: outer surface of the hat

**.AR**



**.BA**



**.AR.BA= OTTONE ANTICHIZZATO**  
AGED BRASS / LAITON VIEILLI / ANTIKISIERTER MESSING

Colori ottone: superficie interna del cappello  
Brass colors: inner surface of the hat



**.VS**

esempio  
example:

3120.AR.VS / 3120.BA.VS  
ottone satinato protetto con vernice trasparente  
brass polished with transparent protection

**CE** IP 20 - E 27  
INDOOR LIGHTING

Max Watt 52



**CLASSE EFFICIENZA  
ENERGETICA A+ ÷ E**  
energy efficiency classes

OTTONE ANTICIZZATO  
AGED BRASS / LAITON VIEILLI / ANTIKISIERTER MESSING



ART. 3120.AR.VS  
H. 900 - Ø 320



OTTONE ANTICIZZATO  
 AGED BRASS / LAITON VIEILLI / ANTIKISIERTER MESSING

Ø 110



①



②



③



④



⑤



⑥



⑦

①  
**ART. 3123.AR.VS**  
 H. 408 - Larg. 511

②  
**ART. 3124.AR.VS**  
 H. 348 - Larg. 365

③  
**ART. 3125.AR.VS**  
 H. 458 - Larg. 620

④  
**ART. 3126.AR.VS**  
 H. 428 - Ø 320

⑤  
**ART. 3127.AR.VS**  
 H. 750 - Ø 320

⑥  
**ART. 3128.AR.VS**  
 H. 900 - Ø 320

⑦  
**ART. 3120.AR.VS**  
 H. 900 - Ø 320  
 Max Watt 53



Colori ottone: superficie esterna del cappello  
 Brass colors: outer surface of the hat

.AR

.BA



**.AR.BA= OTTONE ANTICIZZATO**  
 AGED BRASS / LAITON VIEILLI / ANTIKISIERTER MESSING

Colori ottone: superficie interna del cappello  
 Brass colors: inner surface of the hat



**.VS**

esempio  
 example:

3120.AR.VS / 3120.BA.VS  
 ottone satinato protetto con vernice trasparente  
 brass polished with transparent protection

CE IP 20 - E 27  
 INDOOR LIGHTING

Max Watt 52



LED bulb  
 lampadina a LED

CLASSE EFFICIENZA  
 ENERGETICA A+ ÷ E  
 energy efficiency classes



OTTONE ANTICIZZATO  
AGED BRASS / LAITON VIEILLI / ANTIKISIERTER MESSING

**New**

Art. RM1942

Ø 30

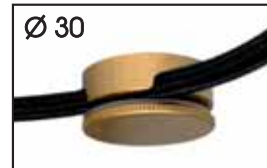

regolazione altezza incluso  
hight adjustement included



ART. 3120R.AR.VS



ART. 3120.3L.AR.VS



ART. 3120.5L.AR.VS



Ø 310

Per 6 e più punti luce  
For 6 light and more

A RICHIESTA: cavo con lunghezza personalizzata e con più luci  
ON REQUEST: custom cable length or with more lights

3120.2L.AR.VS - 3120.4L.AR.VS - 3120.6L.AR.VS

OTTONE ANTICHIZZATO  
AGED BRASS / LAITON VIEILLI / ANTIKISIERTER MESSING



ART. 3120.AR  
H. 900 - Ø 320



ART. 3121.AR  
H. 1000 - Ø 400



ART. 3122.AR  
H. 1000 - Ø 500

Colori ottone: superficie esterna del cappello  
Brass colors: outer surface of the hat

.AR

.BA



.AR.BA= OTTONE ANTICHIZZATO  
AGED BRASS / LAITON VIEILLI / ANTIKISIERTER MESSING

Colori ottone: superficie interna del cappello  
Brass colors: inner surface of the hat



.AR

esempio  
example:

3120.AR / 3120.BA

CE IP 20 - E 27  
INDOOR LIGHTING

Max Watt 52



LED bulb  
lampadina a LED

CLASSE EFFICIENZA  
ENERGETICA A+ ÷ E  
energy efficiency classes

OTTONE ANTICIZZATO  
AGED BRASS / LAITON VIEILLI / ANTIKISIERTER MESSING



**ART. 3120.AR**  
H. 900 - Ø 320







- |   |  |
|---|--|
| ①<br><b>ART. 3123.AR</b><br>H. 408 - Larg. 511            | ②<br><b>ART. 3124.AR</b><br>H. 348 - Larg. 365                       |
| ③<br><b>ART. 3125.AR</b><br>H. 458 - Larg. 620            | ④<br><b>ART. 3126.AR</b><br>H. 428 - Ø 320                           |
| ⑤<br><b>ART. 3127.AR</b><br>H. 750 - Ø 320                | ⑥<br><b>ART. 3128.AR</b><br>H. 900 - Ø 320                           |
| ⑦<br><b>ART. 3120.AR</b><br>H. 900 - Ø 320<br>Max Watt 53 | ⑧<br><b>ART. 3130.AR</b><br>H. min 930<br>H. max 1380<br>Max Watt 53 |

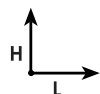

Colori ottone: superficie esterna del cappello  
Brass colors: outer surface of the hat

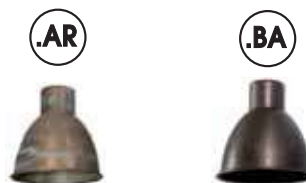

**.AR.BA= OTTONE ANTICIZZATO**  
AGED BRASS / LAITON VIEILLI / ANTIKISIERTER MESSING

Colori ottone: superficie interna del cappello  
Brass colors: inner surface of the hat



**.AR**  
3120.AR / 3120.BA

OTTONE ANTICIZZATO  
AGED BRASS / LAITON VIEILLI  
ANTIKISIERTER MESSING

Art. RM1942

Ø 30



regolazione altezza incluso  
height adjustment included



ART. 3120.3LAR



ART. 3120.2LAR



ART. 3120.5LAR



**New**

A RICHIESTA: cavo con lunghezza personalizzata e con più luci  
ON REQUEST: custom cable length or with more lights

3120.2L - 3120.4L - 3120.6L

Ø 310



Per 6 e più punti luce  
For 6 light and more



Ø 85  
**ART. 1411.E27.AR**  
**ART. 1411.GU10.AR**  
 H. 184 - Larg. 90



Ø 100



**ART. 1520.GU10.AR**  
 H. 150 - Larg. 90



**ART. 1520.E27.AR**  
 H. 150 - Larg. 90



**ART. 1422.E27.AR**  
**ART. 1422.GU10.AR**  
 H. 135 - Larg. 120



**ART. 1412.E27.AR**  
**ART. 1412.GU10.AR**  
 H. 165 - Larg. 190



**ART. 1421.E27.AR**  
**ART. 1421.GU10.AR**  
 H. 165 - Larg. 645

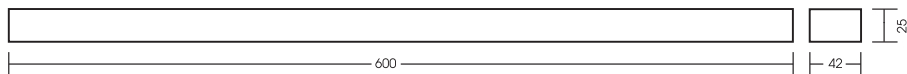
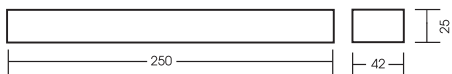





OTTONE ANTICIZZATO  
AGED BRASS / LAITON VIEILLI / ANTIKISIERTER MESSING

**New  
FLEX**



Colori ottone/Couleurs laiton/Brass colors/Messing farbe

**.AR**

**.BA**



**.AR.BA=** OTTONE ANTICIZZATO / AGED BRASS / LAITON VIEILLI / ANTIKISIERTER MESSING

**CE** IP 20 - GU10  
INDOOR LIGHTING

LED GU10  
1 X 28 W  
GU10 A ÷ F



LED bulb  
lampadina a LED

Ø 45 - H. 73

lampadina non inclusa / bulbs not included

**CLASSE EFFICIENZA  
ENERGETICA** A+ ÷ E  
energy efficiency classes

OTTONE ANTICIZZATO  
AGED BRASS / LAITON VIEILLI / ANTIKISIERTER MESSING



ART. 1523.AR  
H. 210 - Ø 116



Colori ottone/Couleurs laiton/Brass colors/Messing farbe

.AR

.BA



.AR.BA= OTTONE ANTICIZZATO / AGED BRASS / LAITON VIEILLI / ANTIKISIERTER MESSING

CE IP 20 - E 27  
INDOOR LIGHTING



Max Watt 28



LED bulb  
lampadina a LED - Ø 45 - H. 73  
lampadina non inclusa / bulbs not included

CLASSE EFFICIENZA  
ENERGETICA A+ ÷ E  
energy efficiency classes

OTTONE ANTICIZZATO  
 AGED BRASS / LAITON VIEILLI / ANTIKISIERTER MESSING



①



②



③

①

ART. 1535.AR  
 H. 225 - Larg. 315

②

ART. 1426.AR  
 H. 225 - Larg. 130

③

ART. 1536.AR  
 H. 225 - Larg. 667



Colori ottone/Couleurs laiton/Brass colors/Messing farbe

.AR

.BA



.AR.BA.NA= OTTONE ANTICIZZATO / AGED BRASS / LAITON VIEILLI / ANTIKISIERTER MESSING

CE IP 20 - E 27  
 INDOOR LIGHTING

Max Watt 28



LED bulb  
 lampadina a LED - Ø 45 - H. 73

lampadina non inclusa / bulbs not included

CLASSE EFFICIENZA  
 ENERGETICA A+ ÷ E  
 energy efficiency classes





OTTONE ANTICIZZATO  
 AGED BRASS / LAITON VIEILLI / ANTIKISIERTER MESSING

Ø 100



ART. 1521.E27.AR  
 ART. 1521.GU10.AR  
 H. 175 - Larg. 95



ART. 1423.E27.AR  
 ART. 1423.GU10.AR  
 H. 135 - Larg. 120



ART. 1548.E27.AR  
 ART. 1548.GU10.AR  
 H. 195 - Larg. 295



ART. 1549.E27.AR  
 ART. 1549.GU10.AR  
 H. 187 - Larg. 645  
 Max Watt 28

Max Watt 28

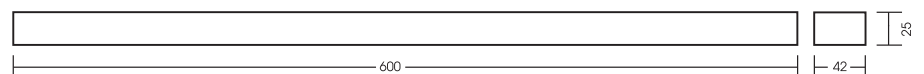
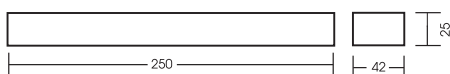



OTTONE ANTICIZZATO  
AGED BRASS / LAITON VIEILLI / ANTIKISIERTER MESSING

**New  
FLEX**



Colori ottone/Couleurs laiton/Brass colors/Messing farbe

**.AR**

**.BA**



**.AR.BA=** OTTONE ANTICIZZATO / AGED BRASS / LAITON VIEILLI / ANTIKISIERTER MESSING

**CE** IP 20 - GU10  
INDOOR LIGHTING  
Max Watt 28

LED GU10  
1 X 28 W  
GU10 A ÷ F

LED bulb  
lampadina a LED  
Ø 45 - H. 73  
lampadina non inclusa / bulbs not included

CLASSE EFFICIENZA  
ENERGETICA A+ ÷ E  
energy efficiency classes

OTTONE ANTICIZZATO  
AGED BRASS / LAITON VIEILLI / ANTIKISIERTER MESSING



**ART. 1460.AR**  
H. 100 - Ø 90



**ART. 1425.AR**  
H. 135 - Larg. 120



**ART. 1462.AR**  
H. 150 - Larg. 250



**ART. 1463.AR**  
H. 150 - Larg. 610

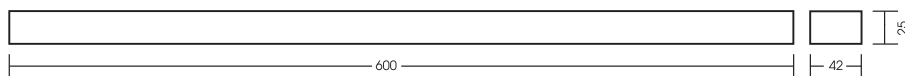
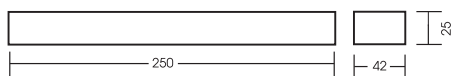



OTTONE ANTICIZZATO  
AGED BRASS / LAITON VIEILLI / ANTIKISIERTER MESSING

**New  
FLEX**



**ART. 1460F.AR**  
H. 120 - Larg. 320  
Max Watt 28

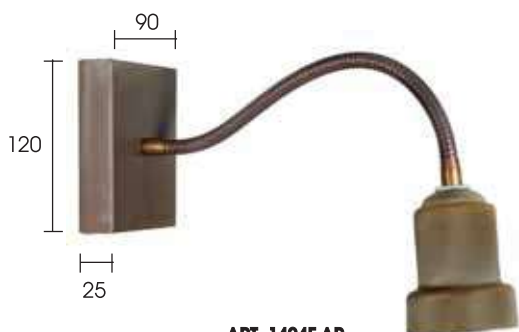

**ART. 1424F.AR**  
H. 120 - Larg. 300  
Max Watt 28



**ART. 1425F.AR**  
H. 390 - Larg. 120  
Max Watt 28



**ART. 1462F.AR**  
H. 390 - Larg. 250  
Max Watt 28



**ART. 1463F.AR**  
H. 390 - Larg. 600  
Max Watt 28

Colori ottone/Couleurs laiton/Brass colors/Messing farbe

**.AR**



**.BA**



**.AR.BA=** OTTONE ANTICIZZATO / AGED BRASS / LAITON VIEILLI / ANTIKISIERTER MESSING

**CE** IP 20 - GU10  
INDOOR LIGHTING

LED GU10  
1 X 28 W

CLASSE EFFICIENZA  
ENERGETICA  
energy efficiency classes  
A+ ÷ E



Ø 110



①



②



③



④



⑤

Ø 320

①

ART. 3123.T.AR  
H. 410 - Larg. 511

②

ART. 3124.T.AR  
H. 350 - Larg. 365

③

ART. 3125.T.AR  
H. 460 - Larg. 620

④

ART. 3126.T.AR  
H. 430 - Ø 320

⑤

ART. 3127.T.AR  
H. 750 - base Ø 110



Colore vetri / Couleurs des opalines / Glass colors / Gläs farbe  
.T = trasparente .O = opale

Colori ottone  
Couleurs laiton/Brass colors/Messing Farbe

.AR



.BA



**.AR.BA= OTTONE ANTICHIZZATO**

AGED BRASS / LAITON VIEILLI / ANTIKISIERTER MESSING

**non teme la salsedine / no problem with salt corrosion**

CE IP 44 - E 27  
OUTDOOR LIGHTING

Max Watt 52



LED bulb  
lampadina a LED

CLASSE EFFICIENZA  
ENERGETICA A+ ÷ E  
energy efficiency classes

Ø 110



⑥  
**ART. 3128.T.AR**  
H. 1000 - Ø 320



⑦  
**ART. 3147.T.AR**  
H. 1000 - Ø 400



⑧  
**ART. 3148.T.AR**  
H. 1000 - Ø 500







①  
ART. 3141.T.AR  
H. 600 - Larg. 520

②  
ART. 3142.T.AR  
H. 730 - Larg. 625

③  
ART. 3137.T.AR  
H. 1550 - Larg. 560

④  
ART. 3138.T.AR  
H. 2700 - Larg. 640

⑤  
ART. 3139.T.AR  
H. 2700 - Larg. 1230

⑥  
ART. 3140.T.AR  
H. 2700 - Larg. 1110



Colore vetri / Couleurs des opalines / Glass colors / Gläs farbe  
.T = trasparente .O = opale

Colori ottone  
Couleurs laiton/Brass colors/Messing Farbe

.AR

.BA



**.AR.BA= OTTONE ANTICHIZZATO**

AGED BRASS / LAITON VIEILLI / ANTIKISIERTER MESSING

**non teme la salsedine / no problem with salt corrosion**

CE IP 44 - E 27  
OUTDOOR LIGHTING

Max Watt 52



LED bulb  
lampadina a LED

CLASSE EFFICIENZA  
ENERGETICA A+ ÷ E  
energy efficiency classes



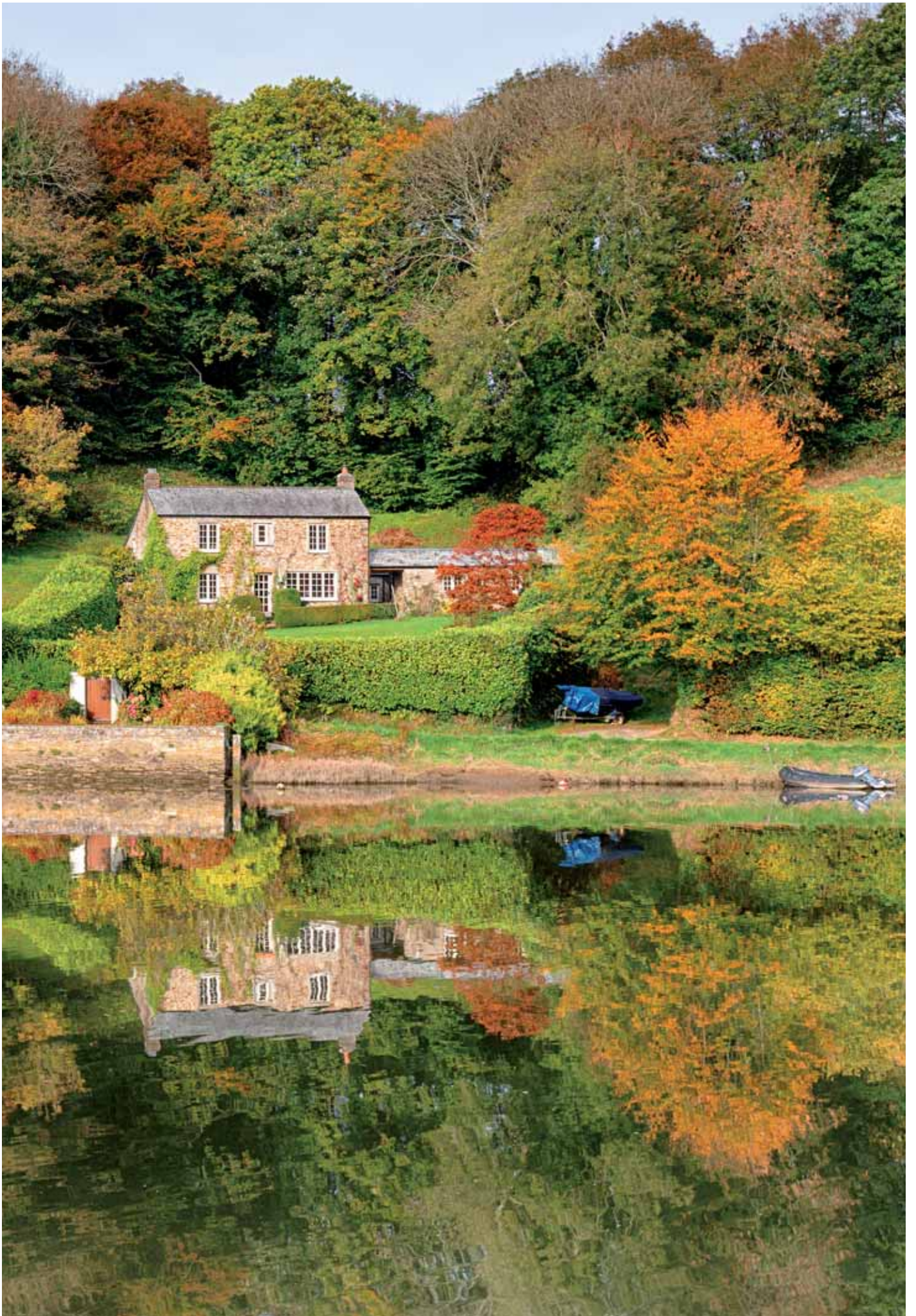



Ø 110



①



②



③

Ø 110



④



⑤

①  
ART. 3330.T.AR  
H. 430 - Larg. 511

②  
ART. 3331.T.AR  
H. 370 - Larg. 366

③  
ART. 3332.T.AR  
H. 480 - Larg. 621

④  
ART. 3333.T.AR  
H. 450 - Ø 320

⑤  
ART. 3334.T.AR  
H. 770 - base Ø 110



Colore vetri / Couleurs des opalines / Glass colors / Gläs farbe  
.T = trasparente .O = opale

Colori ottone  
Couleurs laiton/Brass colors/Messing Farbe

.AR



.BA



**.AR.BA= OTTONE ANTICIZZATO**  
AGED BRASS / LAITON VIEILLI / ANTIKISIERTER MESSING  
**non teme la salsedine / no problem with salt corrosion**



CE IP 44 - E 27  
OUTDOOR LIGHTING

Max Watt 52



LED bulb  
lampadina a LED

CLASSE EFFICIENZA  
ENERGETICA A+ ÷ E  
energy efficiency classes



Ø 110



⑥



⑦



⑧



⑥

**ART. 3335.T.AR**  
H. 1020 - Ø 320

⑦

**ART. 3336.T.AR**  
H. 1020 - Ø 400

⑧

**ART. 3337.T.AR**  
H. 1020 - Ø 500





①  
**ART. 3338.T.AR**  
 H. 620 - Larg. 520

②  
**ART. 3339.T.AR**  
 H. 1550 - Larg. 560

③  
**ART. 3340.T.AR**  
 H. 2700 - Larg. 640

④  
**ART. 3341.T.AR**  
 H. 2700 - Larg. 1230

⑤  
**ART. 3342.T.AR**  
 H. 2700 - Larg. 1110



Colore vetri / Couleurs des opalines / Glass colors / Gläs farbe  
 .T = trasparente .O = opale

Colori ottone  
 Couleurs laiton/Brass colors/Messing Farbe

.AR

.BA



**.AR.BA= OTTONE ANTICIZZATO**  
 AGED BRASS / LAITON VIEILLI / ANTIKISIERTER MESSING  
**non teme la salsedine / no problem with salt corrosion**

CE IP 44 - E 27  
 OUTDOOR LIGHTING

Max Watt 52



LED bulb  
 lampadina a LED

CLASSE EFFICIENZA  
 ENERGETICA A+ ÷ E  
 energy efficiency classes







Ø 110

ART. 1745.AR  
H. 485 - Larg. 330

Colore vetri / Couleurs des opalines / Glass colors / Gläs farbe  
trasparente / transparent

Colori ottone  
Couleurs laiton/Brass colors/Messing Farbe

.AR

.BA



**.AR.BA= OTTONE ANTICHIZZATO**  
AGED BRASS / LAITON VIEILLI / ANTIKISIERTER MESSING  
**non teme la salsedine / no problem with salt corrosion**



Ø 110



**ART. 1746.AR**  
H. 980 - Larg. 150





①

**ART. 1740.T.BA**

H. 500 - Larg. 300 - Ø 240

Kg. 4

**.AR.BA=**

OTTONE ANTICIZZATO

LAITON VIEILLI

AGED BRASS

ANTIKISIERTER MESSING

**non teme la salsedine**

**no problem with  
salt corrosion**

Colore vetri

Couleurs verres

Glass colors

Glás farbe

**.T = trasparente**

CE IP 44 - E 27

Max Watt 52

mm 63



20/23 Watt

**CLASSE EFFICIENZA  
ENERGETICA**  
energy efficiency classes

**A+ ÷ E**



LED bulb  
lampadina a LED

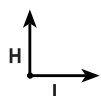





③  
Lampada da tavolo  
da Interni IP 20  
Indoor tablelamp IP 20



②  
**ART. 1742.T.AR**  
H. 1150 - Larg. 240 - Kg. 3,70

③  
**ART. 1743.T.AR**  
H. 500 - Larg. 240 - Kg. 3,60  
IP 20



**.AR.BA=**

OTTONE ANTICIZZATO  
LAITON VIEILLI  
AGED BRASS  
ANTIKISIERTER MESSING

**non teme la salsedine**  
**no problem with**  
**salt corrosion**

Colore vetri  
Couleurs verres  
Glass colors  
Gläs farbe

.T = trasparente

**CLASSE EFFICIENZA**  
**ENERGETICA**  
**energy efficiency classes**  
**A+ ÷ E**

CE IP 44 - E 27

Max Watt 52



20/23 Watt



LED bulb  
lampadina a LED

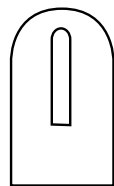

140

①  
ART. 1820.T.AR  
H. 330 - Larg. 180

②  
ART. 1821.T.AR  
H. 330 - Larg. 180



**.AR.AC.BA.NA=**  
OTTONE ANTICIZZATO PER ESTERNI E INTERNI  
AGED BRASS FOR OUTDOOR AND INDOOR  
LAIION VIEILLI  
ANTIKISIERTER MESSING

**non teme la salsedine**  
**no problem with**  
**salt corrosion**

Finitura ottone per Interni  
Indoor brass finishes  
**.A.AR.AC.BA.NA**

Colore vetri  
Couleurs verres  
Glass colors  
Gläs farbe  
.T = trasparente  
.O = opale

CE IP 44 - E 27

Max Watt 52



23/25 Watt  
1500 - 1600LM



LED bulb  
lampadina a LED

Laser Cutting



CLASSE EFFICIENZA ENERGETICA  
energy efficiency classes A+ ÷ E





ART. 1822.T.A

③

ART. 1822.T.AR  
H. 330 - Larg. 180

④

ART. 1823.T.AR  
H. 330 - Larg. 180

Ø 110

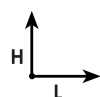





OTTONE ANTICIZZATO  
AGED BRASS / LAITON VIEILLI  
ANTIKISIERTER MESSING

OUTDOOR

**New**



ART. 1950N.T.AR



Ø 110



ART. 1950N.T.AR  
H. 350 - Larg. 285



ART. 1950N.O.AR  
H. 350 - Larg. 285



ART. 1950N.IT.AR  
H. 370 - Larg. 310



ART. 1950N.TO.AR  
H. 370 - Larg. 310

Colori ottone: superficie esterna del cappello  
Brass colors: outer surface of the hat

.AR

.BA



**.AR.BA= OTTONE ANTICIZZATO**  
AGED BRASS / LAITON VIEILLI / ANTIKISIERTER MESSING  
**non teme la salsedine / no problem with salt corrosion**

CE IP 44 - E 27  
OUTDOOR

Max Watt 52



LED bulb  
Lampadina a LED

lampadina non inclusa / bulbs not included

CLASSE EFFICIENZA  
ENERGETICA A+ ÷ E  
energy efficiency classes

OTTONE ANTICIZZATO  
AGED BRASS / LAITON VIEILLI / ANTIKISIERTER MESSING

OUTDOOR

SOSPENSIONE REGOLABILE IN ALTEZZA  
ADJUSTABLE SUSPENSION

Ø 100



ART. 1951N.T.AR  
Ø 120



ART. 1951N.O.AR  
Ø 120



ART. 1951N.TT.AR  
Ø 140



ART. 1951N.TO.AR  
Ø 140

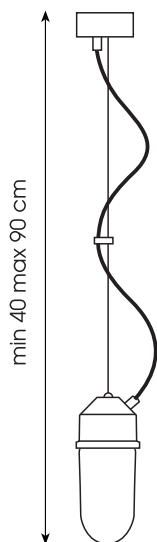

Colori ottone: superficie esterna del cappello  
Brass colors: outer surface of the hat

.AR



.BA



**.AR.BA= OTTONE ANTICIZZATO**  
AGED BRASS / LAITON VIEILLI / ANTIKISIERTER MESSING  
**non teme la salsedine / no problem with salt corrosion**

CE IP 44 - E 27  
OUTDOOR

Max Watt 52



LED bulb  
Lampadina a LED

lampadina non inclusa / bulbs not included

CLASSE EFFICIENZA  
ENERGETICA A+ ÷ E  
energy efficiency classes

Ø 100



ART. 1952N.T.AR  
H. 1050 - Larg. 120



ART. 1952N.O.AR  
H. 1050 - Larg. 120



ART. 1952N.TT.AR  
H. 1070 - Larg. 140



ART. 1952N.TO.AR  
H. 1070 - Larg. 140



Colori ottone: superficie esterna del cappello  
Brass colors: outer surface of the hat



**.AR.BA= OTTONE ANTICIZZATO**  
AGED BRASS / LAITON VIEILLI / ANTIKISIERTER MESSING  
**non teme la salsedine / no problem with salt corrosion**

CE IP 44 - E 27  
OUTDOOR

Max Watt 52



LED bulb  
lampadina a LED

lampadina non inclusa / bulbs not included

CLASSE EFFICIENZA  
ENERGETICA A+ ÷ E  
energy efficiency classes





ART. 18 ML 1 .AR



ART. 18 ML 2 .AR



ART. 1953N.T.AR



ART. 1953N.O.AR



ART. 1953N.TT.AR



ART. 1953N.TO.AR



Ø 100

H. 60

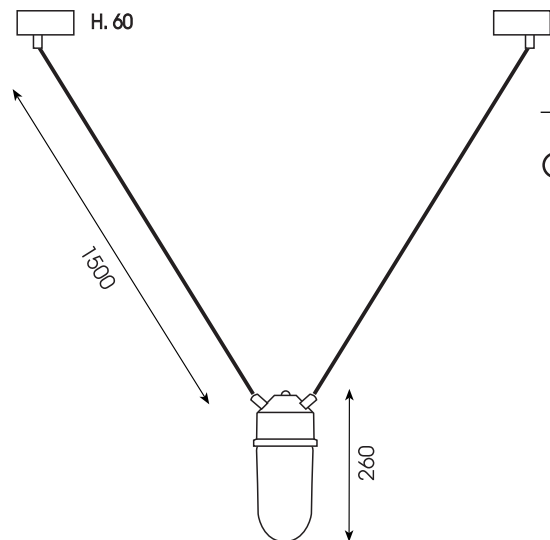

Colori ottone: superficie esterna del cappello  
 Brass colors: outer surface of the hat

.AR



.BA



**.AR.BA = OTTONE ANTICIZZATO**  
 AGED BRASS / LAITON VIEILLI / ANTIKISIERTER MESSING  
**non teme la salsedine / no problem with salt corrosion**

CE IP 44 - E 27  
 OUTDOOR

Max Watt 52

   
 LED bulb  
 Lampadina a LED  
 lampadina non inclusa / bulbs not included

CLASSE EFFICIENZA  
 ENERGETICA A+ ÷ E  
 energy efficiency classes



Ø 110

①



②



③



①  
ART. 1850.O.AR  
H. 480 - Larg. 200

②  
ART. 1851.O.AR  
H. 490 - Larg. 280

③  
ART. 1852.T.AR  
H. 310 - Larg. 190



.AR.AC.BA.NA=  
OTTONE ANTICIZZATO PER ESTERNI E INTERNI  
AGED BRASS FOR OUTDOOR AND INDOOR  
LAITON VIEILLI  
ANTIKISIERTER MESSING

**non teme la salsedine**  
**no problem with salt corrosion**

Finitura ottone per interni  
Indoor brass finishes  
.A.AR.AC.BA.NA

Colore vetri  
Couleurs verres  
Glass colors  
Gläs farbe

.T = trasparente  
.O = opale

CE IP 44 - E 27

Max Watt 52

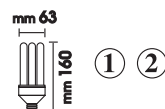

23/25 Watt  
1500 - 1600LM

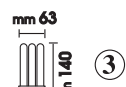

20/23 Watt

CLASSE EFFICIENZA  
ENERGETICA  
energy efficiency classes  
A+ ÷ E



LED bulb  
lampadina a LED



Ø 110



④



⑤



⑥

④  
ART. 1853.T.AR  
H. 360 - Larg. 240

⑤  
ART. 1854.O.AR  
H. 370 - Larg. 150

⑥  
ART. 1855.O.AR  
H. 890 - Larg. 150

**.AR.AC.BA.NA=**  
OTTONE ANTICIZZATO PER ESTERNI E INTERNI  
AGED BRASS FOR OUTDOOR AND INDOOR  
L'AITON VIEILLI  
ANTIKISIERTER MESSING

**non teme la salsedine**  
**no problem with salt corrosion**

Finitura ottone per Interni  
Indoor brass finishes  
**.A.AR.AC.BA.NA**

Colore vetri  
Couleurs verres  
Glass colors  
Gläs farbe  
.T = trasparente  
.O = opale

CE IP 44 - E 27  
Max Watt 52

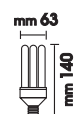

20/23 Watt  
1500 - 1600LM

**CLASSE EFFICIENZA**  
**ENERGETICA**  
energy efficiency classes  
**A+ ÷ E**



LED bulb  
lampadina a LED







④  
**ART. 1859.O.AR**  
 H. 520 - Larg. 140

⑤  
**ART. 1860.O.AR**  
 H. 115 - Larg. 140



**.AR.AC.BA=**

OTTONE ANTICIZZATO  
 PER ESTERNI E INTERNI

AGED BRASS FOR  
 OUTDOOR AND INDOOR

LAITON VIEILLI

ANTIKISIERTER MESSING

**non teme la salsedine**

**no problem with  
 salt corrosion**

Finitura ottone per Interni  
 Indoor brass finishes

**.AR.AC.BA**

Colore vetri

Couleurs verres

Glass colors

Gläs farbe

.T = trasparente

.O = opale

CE IP 44 - E 27

Max Watt 52

mm 63



23/25 Watt

1500 - 1600LM



LED bulb  
 lampadina a LED

CLASSE EFFICIENZA ENERGETICA  
 energy efficiency classes A+ ÷ E

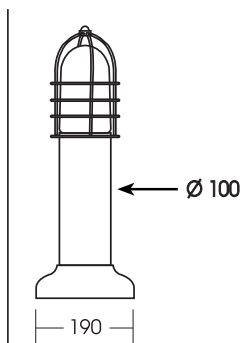
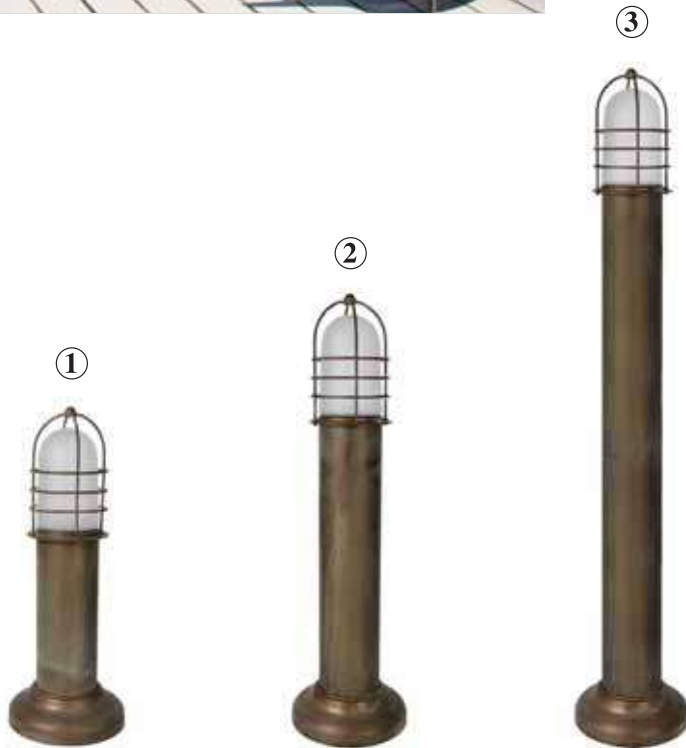

①  
**ART. 1856.O.AR**  
 H. 510 - Larg. 190

②  
**ART. 1857.O.AR**  
 H. 710 - Larg. 190

③  
**ART. 1858.O.AR**  
 H. 1230 - Larg. 190



**.AR.AC.BA=**  
 OTTONE ANTICIZZATO  
 PER ESTERNI E INTERNI

AGED BRASS FOR  
 OUTDOOR AND INDOOR

LAITON VIEILLI  
 ANTIKISIERTER MESSING

**non teme la salsedine**  
**no problem with salt corrosion**

Finitura ottone per Interni  
 Indoor brass finishes  
**.AR.AC.BA**

Colore vetri  
 Couleurs verres  
 Glass colors  
 Gläs farbe

.T = trasparente  
 .O = opale

CE IP 44 - E 27  
 Max Watt 52



23/25 Watt  
 1500 - 1600LM



LED bulb  
 lampadina a LED

**CLASSE EFFICIENZA ENERGETICA**  
 energy efficiency classes **A+ ÷ E**



piastra a muro  
Ø 110

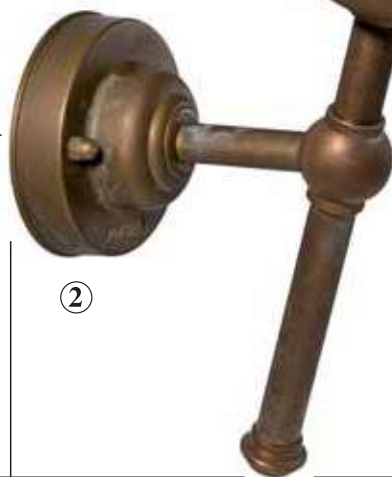

Larg. 300



①  
ART. 1890.O.AR  
H. 455 - Larg. 190

②  
ART. 1891.O.AR  
H. 455 - Larg. 130  
Prof. 300

③  
ART. 1892.T.AR  
H. 285 - Larg. 185

**.AR.AC.BA.NA=**  
OTTONE ANTICIZZATO PER ESTERNI E INTERNI  
AGED BRASS FOR OUTDOOR AND INDOOR  
LAITON VIEILLI  
ANTIKISIERTER MESSING

**non teme la salsedine**  
**no problem with**  
**salt corrosion**

Finitura ottone per interni  
Indoor brass finishes  
**.A.AR.AC.BA.NA**

Colore vetri  
Couleurs verres  
Glass colors  
Gläs farbe  
.T = trasparente  
.O = opale

CE IP 44 - E 27  
Max Watt 52

mm 63  
mm 160 ① ②

23/25 Watt  
1500 - 1600LM

mm 63  
mm 140 ③  
20/23 Watt

**CLASSE EFFICIENZA**  
**ENERGETICA**  
energy efficiency classes  
**A+ ÷ E**

 LED bulb  
lampadina a LED







④



⑤

④

**ART. 1893.O.AR**  
H. 320 - Larg. 145

⑤

**ART. 1894.O.AR**  
H. 330 - Larg. 245

**.AR.AC.BA.NA=**  
OTTONE ANTICIZZATO PER ESTERNI E INTERNI  
AGED BRASS FOR OUTDOOR AND INDOOR  
LAITON VIEILLI  
ANTIKISIERTER MESSING

**non teme la salsedine**  
**no problem with**  
**salt corrosion**

Finitura ottone per interni  
Indoor brass finishes  
**.A.AR.AC.BA.NA**

Colore vetri  
Couleurs verres  
Glass colors  
Gläs farbe  
.T = trasparente  
.O = opale



CE IP 44 - E 27

Max Watt 52



20/23 Watt

**CLASSE EFFICIENZA**  
**ENERGETICA**  
energy efficiency classes  
**A+ ÷ E**



LED bulb  
lampadina a LED



①

①  
**ART. 1870.O.AR**  
 H. 490 - Larg. 210

②  
**ART. 1871.O.AR**  
 H. 490 - Larg. 300

③  
**ART. 1872.T.AR**  
 H. 310 - Larg. 200



②

**.AR.AC.BA.NA=**  
 OTTONE ANTICHIZZATO PER ESTERNI E INTERNI  
 AGED BRASS FOR OUTDOOR AND INDOOR  
 LAITON VIEILLI  
 ANTIKISIERTER MESSING

**non teme la salsedine**  
**no problem with salt corrosion**

Finitura ottone per interni  
 Indoor brass finishes  
**.A.AR.AC.BA.NA**

Colore vetri  
 Couleurs verres  
 Glass colors  
 Gläs farbe  
 .T = trasparente  
 .O = opale

CE IP 44 - E 27

Max Watt 52

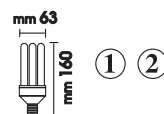

① ②

23/25 Watt  
 1500 - 1600LM

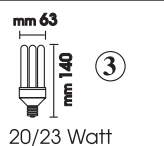

③

20/23 Watt



③

**CLASSE EFFICIENZA**  
**ENERGETICA**  
 energy efficiency classes  
**A+ ÷ E**



LED bulb  
 lampadina a LED

①

ART. 1873.O.AR  
H. 510 - Larg. 190

②

ART. 1874.O.AR  
H. 710 - Larg. 190

③

ART. 1875.O.AR  
H. 1230 - Larg. 190

④

ART. 1876.O.AR  
H. 520 - Larg. 140

⑤

ART. 1877.O.AR  
H. 115 - Larg. 140



CE IP 44 - E 27

Max Watt 52

mm 63



23/25 Watt

1500 - 1600LM

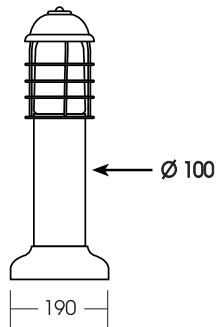

.AR.AC.BA=

OTTONE ANTICIZZATO  
PER ESTERNI E INTERNI  
AGED BRASS FOR  
OUTDOOR AND INDOOR  
LAITON VIEILLI  
ANTIKISIERTER MESSING

**non teme la salsedine**  
**no problem with**  
**salt corrosion**

Finitura ottone per Interni  
Indoor brass finishes  
**.AR.AC.BA**

Colore vetri  
Couleurs verres  
Glass colors  
Gläs farbe  
.T = trasparente  
.O = opale

CLASSE EFFICIENZA  
ENERGETICA  
energy efficiency classes

A+ ÷ E



LED bulb  
lampadina a LED

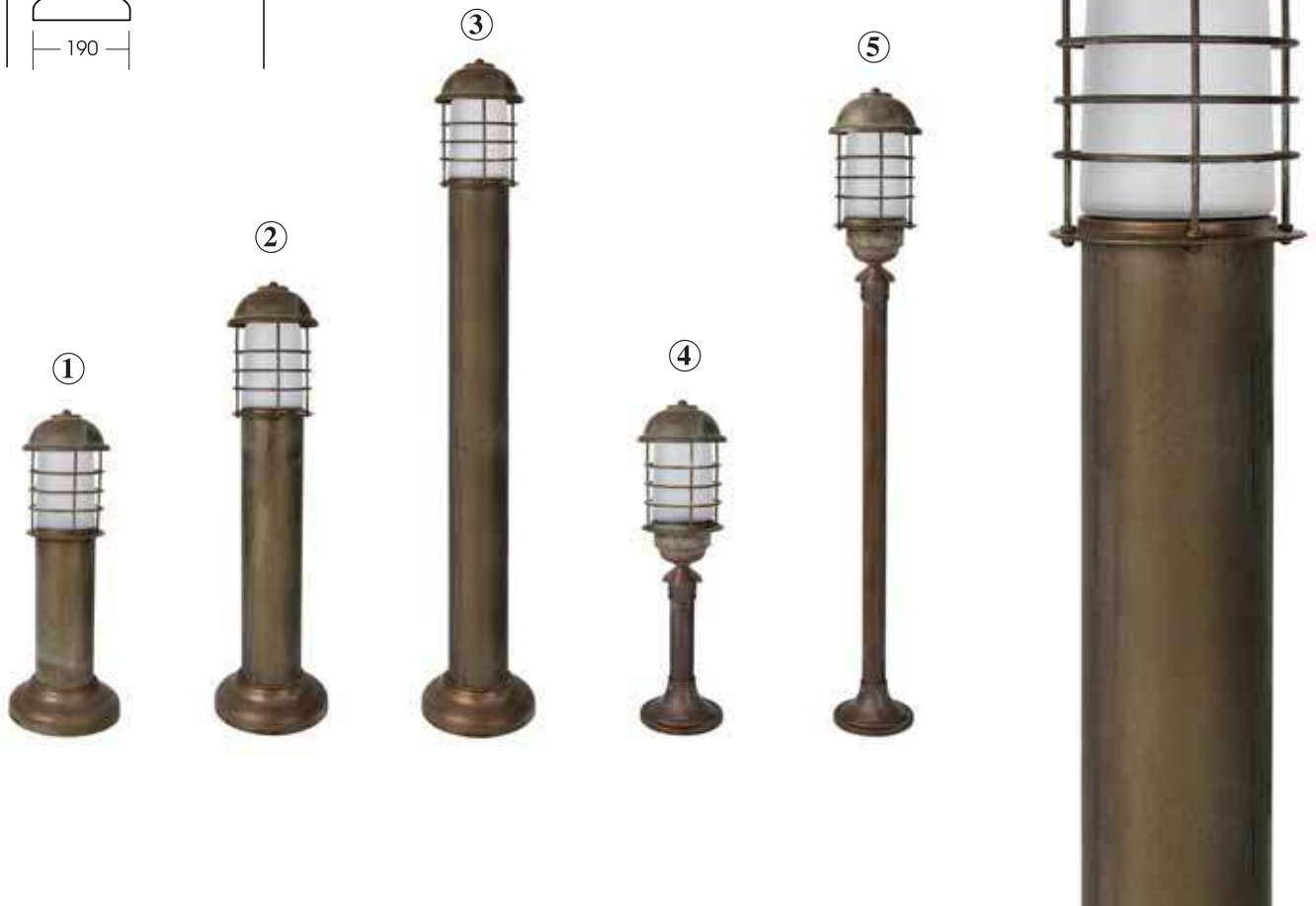





①  
ART. 1900.O.AR  
H. 500 - Larg. 250

②  
ART. 1901.O.AR  
H. 480 - Larg. 310

③  
ART. 1901.O.AC  
H. 480 - Larg. 310

④  
ART. 1902.O.AR  
H. 310 - Larg. 245



**.AR.AC.BA.NA=**

OTTONE ANTICIZZATO  
PER ESTERNI E INTERNI

AGED BRASS FOR  
OUTDOOR AND INDOOR

LAITON VIEILLI

ANTIKISIERTER MESSING

**non teme la salsedine**  
**no problem with**  
**salt corrosion**

Finitura ottone per interni  
Indoor brass finishes  
**.AR.AC.BA.NA**

Colore vetri  
Couleurs verres  
Glass colors  
Gläs farbe  
.T = trasparente  
.O = opale

CE IP 44 - E 27

Max Watt 52

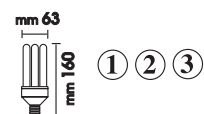

23/25 Watt  
1500 - 1600LM

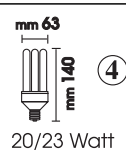

20/23 Watt

**CLASSE EFFICIENZA  
ENERGETICA**  
energy efficiency classes

**A+ ÷ E**



LED bulb  
lampadina a LED

①  
**ART. 1903.O.AR**  
H. 510 - Larg. 190

②  
**ART. 1904.O.AR**  
H. 710 - Larg. 190

③  
**ART. 1905.O.AR**  
H. 1230 - Larg. 190

④  
**ART. 1906.O.AR**  
H. 520 - Larg. 140

⑤  
**ART. 1907.O.AR**  
H. 115 - Larg. 140



CE IP 44 - E 27

Max Watt 52



23/25 Watt

1500 - 1600LM

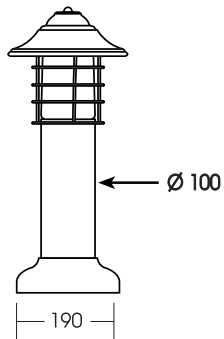

**.AR.AC.BA=**

OTTONE ANTICIZZATO  
PER ESTERNI E INTERNI

AGED BRASS FOR  
OUTDOOR AND INDOOR

LAITON VIEILLI

ANTIKISIERTER MESSING

**non teme la salsedine  
no problem with  
salt corrosion**

Finitura ottone per interni  
Indoor brass finishes

**.AR.AC.BA**

Colore vetri  
Couleurs verres  
Glass colors  
Glás farbe  
.T = trasparente  
.O = opale

**CLASSE EFFICIENZA  
ENERGETICA**  
energy efficiency classes

**A+ ÷ E**



LED bulb  
lampadina a LED





①  
**ART. 1840.O.AR**  
 H. 130 - Larg. 260

②  
**ART. 1841.O.AR**  
 H. 130 - Larg. 260



**.AR.AC.BA.NA=**  
 OTTONE ANTICIZZATO  
 PER ESTERNI E INTERNI  
 AGED BRASS FOR  
 OUTDOOR AND INDOOR  
 LAITON VIEILLI  
 ANTIKISIERTER MESSING

**non teme la salsedine**  
**no problem with**  
**salt corrosion**

Finitura ottone per interni  
 Indoor brass finishes  
**.A.AR.AC.BA.NA**

Colore vetri  
 Couleurs verres  
 Glass colors  
 Gläs farbe  
 .T = trasparente  
 .O = opale

**CLASSE EFFICIENZA  
 ENERGETICA**  
 energy efficiency classes  
**A+ ÷ E**



Ⓒ IP 44 - E 27  
 Max Watt 52

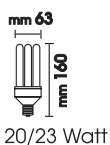

①



②



①





①

**ART. 1962.O.AR**  
H. 1030 - Larg. 400

**.AR.AC.BA.NA=**  
OTTONE ANTICIZZATO PER ESTERNI E INTERNI  
AGED BRASS FOR OUTDOOR AND INDOOR  
LAITON VIEILLI  
ANTIKISIERTER MESSING

**non teme la salsedine**  
**no problem with salt corrosion**

Finitura ottone per Interni  
Indoor brass finishes  
**.A.AR.AC.BA.NA**

Colore vetri  
Couleurs verres  
Glass colors  
Glás farbe

**.T = trasparente**  
**.O = opale**

CE IP 44 - E 27

Max Watt 52

mm 63

mm 160

**CLASSE EFFICIENZA  
ENERGETICA**  
energy efficiency classes  
**A+ ÷ E**



LED bulb  
lampadina a LED

①



OTTONE ANTICIZZATO  
 AGED BRASS / LAITON VIEILLI / ANTIKISIERTER MESSING

Ø 110



①

②

③

Ø 110



④

⑤

⑥

Ø 300

①  
**ART. 3300.T.AR**  
 H. 350 - Larg. 510

②  
**ART. 3301.T.AR**  
 H. 350 - Larg. 620

③  
**ART. 3303.T.AR**  
 H. 350 - Larg. 365

④  
**ART. 3307.T.AR**  
 H. 350 - Ø 300

⑤  
**ART. 3306.T.AR**  
 H. 670 - base Ø 110  
 heat Ø 300

⑥  
**ART. 3302.T.AR**  
 H. 900 - Ø 300



Colore vetri / Couleurs des opalines / Glass colors / Gläs farbe  
 .T = trasparente .O = opale

Colori ottone  
 Couleurs laiton/Brass colors/Messing Farbe



**.AR.BA= OTTONE ANTICIZZATO**  
 AGED BRASS / LAITON VIEILLI / ANTIKISIERTER MESSING  
**non teme la salsedine / no problem with salt corrosion**



CE IP 44 - E 27  
 OUTDOOR LIGHTING

Max Watt 52



CLASSE EFFICIENZA  
 ENERGETICA A+ ÷ E  
 energy efficiency classes

OTTONE ANTICIZZATO  
 AGED BRASS / LAITON VIEILLI / ANTIKISIERTER MESSING



①



②



③



④



⑤

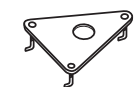
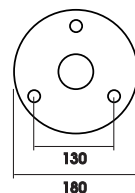

**Piastra  
 fissaggio  
 cod. APR8**

①

**ART. 3313.T.AR**  
 H. 600 - Larg. 520

②

**ART. 3314.T.AR**  
 H. 1550 - Larg. 550

③

**ART. 3315.T.AR**  
 H. 2700 - Larg. 640

④

**ART. 3316.T.AR**  
 H. 2700 - Larg. 1228

⑤

**ART. 3317.T.AR**  
 H. 2700 - Larg. 1108







Colore vetri / Couleurs des opalines / Glass colors / Gläs farbe  
.T = trasparente .O = opale

Colori ottone  
Couleurs laiton/Brass colors/Messing Farbe

.AR

.BA



**.AR.BA= OTTONE ANTICHIZZATO**  
AGED BRASS / LAITON VIEILLI / ANTIKISIERTER MESSING  
**non teme la salsedine / no problem with salt corrosion**



OTTONE ANTICHIZZATO  
AGED BRASS / LAITON VIEILLI / ANTIKISIERTER MESSING



④  
**ART. 3310.AR**  
H. min 800 - max 1300 - Larg. 1100



⑤  
**ART. 3311.BA**  
H. min 800 - max 1300 - Larg. 1300



Ø 110



①



②

Ø 250

Ø 110



③



④

①

ART. 3350.T.AR  
 H. 360 - Larg. 315

②

ART. 3351.T.AR  
 H. 300 - Larg. 496

③

ART. 3352.T.AR  
 H. 310 - Ø 250

④

ART. 3353.T.AR  
 H. 930 - Ø 250



Colore vetri / Couleurs des opalines / Glass colors / Gläs farbe  
 .T = trasparente .O = opale

Colori ottone  
 Couleurs laiton/Brass colors/Messing Farbe

.AR



.BA



**.AR.BA= OTTONE ANTICIZZATO**  
 AGED BRASS / LAITON VIEILLI / ANTIKISIERTER MESSING  
**non teme la salsedine / no problem with salt corrosion**



OTTONE ANTICIZZATO  
AGED BRASS / LAITON VIEILLI / ANTIKISIERTER MESSING

Art. RM1942

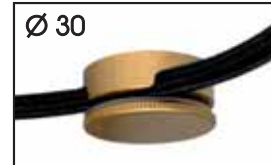

regolazione altezza incluso  
hight adjustement included

base Ø 100



**ART. 1934.AR**  
H. 200 - Larg. 170 - Ø 160



**ART. 3354.AR**  
Cavo / Cable 1500

A RICHIESTA: cavo con lunghezza personalizzata e con più luci  
ON REQUEST: custom cable length or with more lights

3354.1L - 3354.2L - 3354.3L - 3354.4L - 3354.6L - 3354.7L

CE IP 20 - E 27  
INDOOR LIGHTING

Max Watt 52



LED bulb  
lampadina a LED

CLASSE EFFICIENZA  
ENERGETICA A+ ÷ E  
energy efficiency classes



①  
**ART. 1590.T.AR**  
 H. 310 - Larg. 500 - Ø 325

②  
**ART. 1595.T.BA**  
 H. 340 - Larg. 365

③  
**ART. 1591.T.AR**  
 H. 360 - Larg. 620  
 Inclinazione cappello 45°

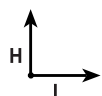

**.AR.BA=**  
 OTTONE ANTICIZZATO  
 LAITON VIEILLI  
 AGED BRASS  
 ANTIKISIRTER MESSING

**non teme la salsedine**  
**no problem with**  
**salt corrosion**

Colore vetri  
 Couleurs verres  
 Glass colors  
 Gläs farbe  
**.T = trasparente**  
**.O = opale**

CE IP 44 - E 27

Max Watt 52

mm 63



20/23 Watt



LED bulb  
 lampadina a LED

**CLASSE EFFICIENZA ENERGETICA**  
**energy efficiency classes** A+ ÷ E





④

Ø 325

④  
ART. 1593.T.AR  
H. 330 - Ø 325

⑤  
ART. 1594.T.AR  
H. 650 - Ø 325

⑥  
ART. 1592.T.AR  
H. 890 - Ø 325

⑦  
ART. 1592.TT.AR  
H. 890 - Ø 325



Ø 110

⑤



⑥

ART. 1592.T.AR trasparente  
ART. 1592.TO.AR opale



⑦

ART. 1592.TT.AR trasparente  
ART. 1592.TO.AR opale

Vetri disponibili in due forme diverse  
Glasses available in two different shapes





Ø 380



ART. 1781.AR



CE IP 20 - E 27

Max Watt 2 x 23 - Philips 23 W / 827

VETRO: OPALE / GLASS: OPAL



①

①

ART. 1676.AR  
H. 220 - Ø 325

②

ART. 1677.AR  
H. min 800 - max 1300  
Larg. 1100

③

ART. 1780.AR  
H. 780 - Ø 325



②



③



Ø 325

.AR.BA=  
OTTONE ANTICHIZZATO  
LATON VIEILLI  
AGED BRASS  
ANTIKISIERTER MESSING

**non teme la salsedine**  
**no problem with**  
**salt corrosion**

Cavo tessuto  
Cable tissue  
Câble tissu  
Kabel stoff

CE IP 20 - E 27

Max Watt 52



20/23 Watt

CLASSE EFFICIENZA  
ENERGETICA  
energy efficiency classes  
A+ ÷ E



LED bulb  
lampadina a LED



ART. 1671.AR



ART. 1670.AR



ART. 1675.BA

A RICHIESTA ANCHE CON VETRO / WITH GLASS TOO / AUSSI AVEC VERRE / AUCH MIT GLÄS

.T.O



② ③ ④ ⑤ con  
with  
avec 



④  
**ART. 1678.BA**  
H. min 820 - max 1250  
Larg. 1310

⑤  
**ART. 1679.BA**  
H. min 600 - max 960  
Larg. 1020

⑥  
**ART. 1596.T.AR**  
(con vetro/with glass)  
**ART. 1596.AR**  
(senza vetro/without glass)



ART. 1672.AR



ART. 1673.AR



ART. 1674.AR

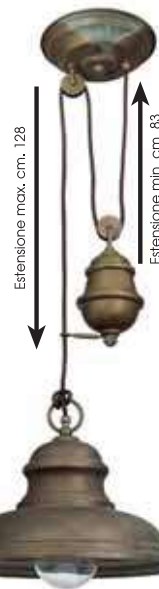

A RICHIESTA ANCHE CON VETRO / WITH GLASS TOO / AUSSI AVEC VERRE / AUCH MIT GLÄS .T.O

**New**



ART. 1780R.AR



a richiesta / on request: .VS



ART. 1780.3L.AR



a richiesta / on request: .VS





**New**



Art. RM1942

Ø 30

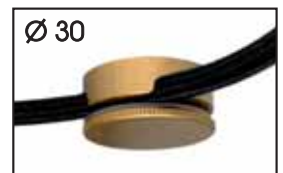

regolazione altezza incluso  
hight adjustment included



Ø 310

Per 6 e più punti luce  
For 6 light and more

A RICHIESTA: cavo con lunghezza personalizzata e con più luci  
ON REQUEST: custom cable length or with more lights

1780.2.LAR - 1780.4.LAR - 1780.6.LAR



①  
**ART. 1720.T.AR**  
 H. 730 - Larg. 620 - Kg. 3,70

②  
**ART. 1721.T.AR**  
 H. 3080 - Larg. 650 - Kg. 17

③  
**ART. 1722.T.AR**  
 H. 3080 - Larg. 1250 - Kg. 20



**.AR.BA=**  
 OTTONE ANTICHIZZATO  
 LAITON VIEILLI  
 AGED BRASS  
 ANTIKISIERTER MESSING

**no teme la salsedine**  
**no problem with**  
**salt corrosion**

Colore vetri  
 Couleurs verres  
 Glass colors  
 Gläs farbe  
 .T = trasparente  
 .O = opale

Palo IP 55 Lanterna IP 44  
 Pole IP 55 Light IP 44  
 Pleu IP 55 Lumiere IP 44

CE IP 44 - E 27  
 Max Watt 52



20/23 Wat



LED bulb  
 lampadina a LED



PIASTRA

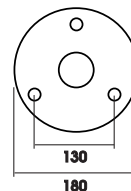
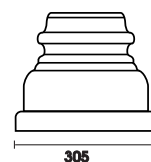

**CLASSE EFFICIENZA ENERGETICA**  
**energy efficiency classes** A+ ÷ E





Ø 325

④



⑤

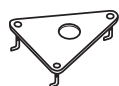

**Piastra  
fissaggio  
cod. APR8**

④

**ART. 1722.T.BA**  
H. 3080 - Larg. 1250  
Kg. 20

**.AR.BA=**  
OTTONE ANTICIZZATO  
LAITON VIEILLI  
AGED BRASS  
ANTIKISIERTER MESSING

⑤

**ART. 1723.T.AR**  
H. 3080 - Larg. 1130  
Kg. 24

**non teme la salsedine**

**no problem with  
salt corrosion**

Colore vetri  
Couleurs verres  
Glass colors  
Glás farbe

.T = trasparente

.O = opale



CE IP 44 - E 27

Max Watt 52



20/23 Watt



LED bulb  
lampadina a LED

**CLASSE EFFICIENZA ENERGETICA - energy efficiency classes A+ ÷ E**







①  
**ART. 1734.T.AR**  
H. 600 - Larg. 520  
Kg. 2,70

②  
**ART. 1730.T.AR**  
H. 730 - Larg. 620  
Kg. 3,90

③  
**ART. 1735.T.AR**  
H. 155 - Larg. 560  
Kg. 8,80

④  
**ART. 1731.T.AR**  
H. 3080 - Larg. 650  
Kg. 16,4

⑤  
**ART. 1732.T.AR**  
H. 3080 - Larg. 1250  
Kg. 19

⑥  
**ART. 1733.T.AR**  
H. 3080 - Larg. 1130  
Kg. 22

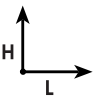

**.AR.BA=**  
OTTONE ANTICHIZZATO  
LAITON VIEILLI  
AGED BRASS  
ANTI-KISIERTER MESSING

**non teme la salsedine**  
**no problem with**  
**salt corrosion**

Colore vetri  
Couleurs verres  
Glass colors  
Gläs farbe  
.T = trasparente  
.O = opale

**CLASSE EFFICIENZA**  
**ENERGETICA**  
energy efficiency classes  
**A+ ÷ E**

Palo **IP 55** Lanterna **IP 44**  
Pole **IP 55** Light **IP 44**  
Pieu **IP 55** Lumiere **IP 44**

**CE** IP 44 - E 27

Max Watt 52



20/23 Watt



LED bulb  
lampadina a LED

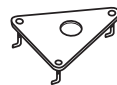

**Piastra**  
**fissaggio**  
**cod. APR8**



**PIASTRA**

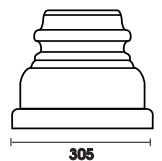

305

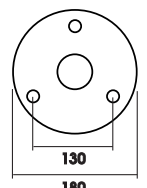

180







①

Ø 325



②

③

205



①

ART. 1734.T.AR  
H. 600 - Larg. 520

②

ART. 1739.T.AR  
H. 1550 - Larg. 560

③

ART. 1736.T.AR  
H. 2700 - Larg. 640

.AR,BA=

OTTONE ANTICIZZATO  
LATON VIEILLI  
AGED BRASS  
ANTIKISIERTER MESSING

**non teme la salsedine**  
**no problem with**  
**salt corrosion**

Colore vetri  
Couleurs verres  
Glass colors  
Gläs farbe

.T = trasparente  
.O = opale

**CLASSE EFFICIENZA**  
**ENERGETICA**  
**energy efficiency classes**

**A+ ÷ E**

CE IP 44 - E 27

Max Watt 52

mm 63



20/23 Watt



LED bulb  
lampadina a LED

205

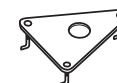
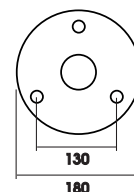

**Piastra**  
**fissaggio**  
**cod. APR8**







④  
**ART. 1737.T.AR**  
 H. 2700 - Larg. 1230

⑤  
**ART. 1738.T.AR**  
 H. 2700 - Larg. 1110

**.AR.BA=**  
 OTTONE ANTICIZZATO  
 LAITON VIEILLI  
 AGED BRASS  
 ANTIKISIERTER MESSING

**non teme la salsedine**  
**no problem with**  
**salt corrosion**

Colore vetri  
 Couleurs verres  
 Glass colors  
 Gläs farbe  
**.T = trasparente**  
**.O = opale**

CE IP 44 - E 27  
 Max Watt 52

mm 63  
 mm 160  
 20/23 Watt

**CLASSE EFFICIENZA**  
**ENERGETICA**  
 energy efficiency classes  
**A+ ÷ E**



LED bulb  
 lampadina a LED

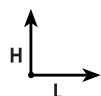



Ø 110



Ø 300



①  
ART. 1350.T.AR  
H. 350 - Larg. 510

②  
ART. 1353.T.AR  
H. 350 - Larg. 365

③  
ART. 1351.T.AR  
H. 350 - Larg. 620

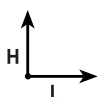

.AR.BA=  
OTTONE ANTICHIZZATO  
LAITON VIELLI  
AGED BRASS  
ANTIKISIERTER MESSING

**non teme la salsedine**  
**no problem with**  
**salt corrosion**

Colore vetri  
Couleurs verres  
Glass colors  
Gläs farbe  
.T = trasparente  
.O = opale

CE IP 44 - E 27

Max Watt 52



20/23 Watt



LED bulb  
lampadina a LED

CLASSE EFFICIENZA ENERGETICA  
energy efficiency classes A+ ÷ E





④  
ART. 1352.T.AR  
H. 900

⑤  
ART. 1356.T.AR  
H. 670 - base Ø 110  
height Ø 300

⑥  
ART. 1357.T.AR  
H. 350 - Ø 300  
ART. 1357.TT.AR  
H. 350 - Ø 300



Ø 110

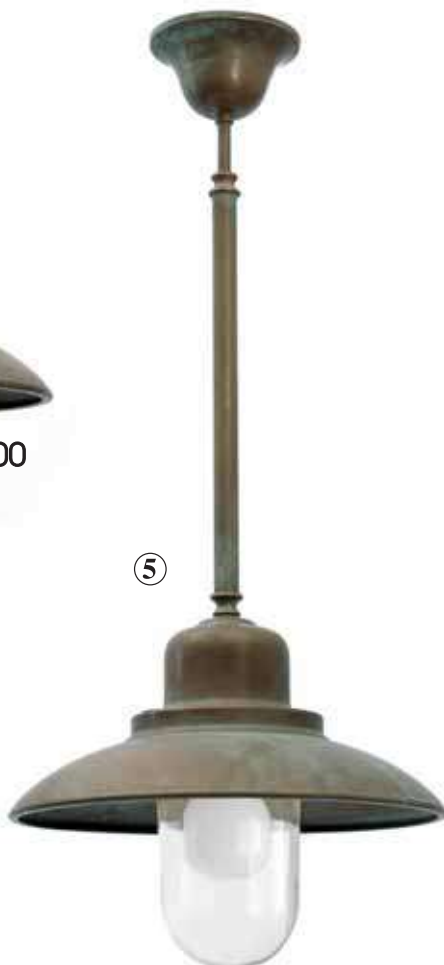

ART. 1357.T.AR trasparente  
ART. 1357.O.AR opale



ART. 1357.TT.AR trasparente  
ART. 1357.TTO.AR opale

Vetri disponibili in due forme diverse  
Glasses available in two different shapes





①

①  
**ART. 1697.AR**  
 H. 830 - Ø 300

②  
**ART. 1698.BA**  
 H. min 710 - max 1070  
 Larg. 1000

③  
**ART. 1696.BA**  
 H. 220 - Ø 300

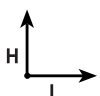

**.AR.BA=**  
 OTTONE ANTICIZZATO  
 LAITON VIEILLI  
 AGED BRASS  
 ANTIKISIERTER MESSING

**non teme la salsedine  
 no problem with  
 salt corrosion**

Cavo tessuto  
*Cable tissu*  
*Câble tissu*  
*Kabel stoff*

CE IP 20 - E 27  
 ⚡ Max Watt 52



**CLASSE EFFICIENZA ENERGETICA**  
 energy efficiency classes **A+ ÷ E**

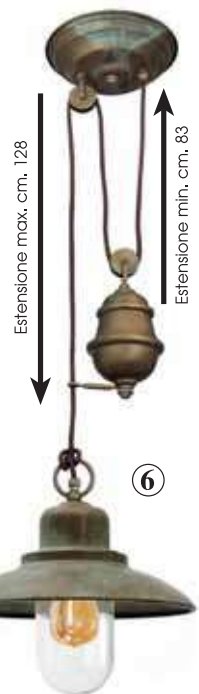

A RICHIESTA ANCHE CON VETRO / WITH GLASS TOO / AUSSI AVEC VERRE / AUCH MIT GLÄS .T.O



① ② ④ ⑤ con  
with  
avec 

④  
**ART. 1699.AR**  
H. min 800 - max 1300 - Larg. 1090

⑤  
**ART. 1712.BA**  
H. min 800 - max 1300 - Larg. 1280

⑥  
**ART. 1354.T.AR**  
(con vetro/with glass)  
**ART. 1354.AR**  
(senza vetro/without glass)

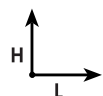

ART. 1690.AR



ART. 1692.AR



ART. 1695.AR



ART. 1694.AR



ART. 1693.AR

A RICHIESTA ANCHE CON VETRO / WITH GLASS TOO / AUSSI AVEC VERRE / AUCH MIT GLÄS .T.O



**New**



ART. 1697R.AR



a richiesta / on request: .VS



ART. 1697.3LAR



a richiesta / on request: .VS

CE IP 20 - E 27  
INDOOR LIGHTING

Max Watt 52



LED bulb  
lampadina a LED

CLASSE EFFICIENZA  
ENERGETICA A+ ÷ E  
energy efficiency classes





**New**

ART. 1697.5LAR



Art. RM1942

Ø 30

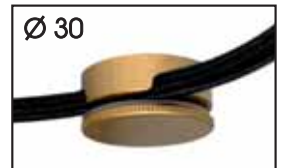

regolazione altezza incluso  
height adjustment included

Ø 310



Per 6 e più punti luce  
For 6 light and more

A RICHIESTA: cavo con lunghezza personalizzata e con più luci  
ON REQUEST: custom cable length or with more lights

1697.2LAR - 1697.4LAR - 1697.6LAR



Ø 300



①

ART. 1760.T.AR  
H. 600 - Larg. 520

②

ART. 1765.T.AR  
H. 1550 - Larg. 550

③

ART. 1761.T.AR  
H. 2700 - Larg. 640



**.AR.BA=**

OTTONE ANTICHIZZATO  
LATON VIEILLI  
AGED BRASS  
ANTIKISIERTER MESSING

**non teme la salsedine**  
**no problem with**  
**salt corrosion**

Colore vetri  
Couleurs verres  
Glass colors  
Gläs farbe

**.T = trasparente**

**.O = opale**

**CLASSE EFFICIENZA**  
**ENERGETICA**  
**energy efficiency classes**

**A+ ÷ E**

CE IP 44 - E 27

Max Watt 52

mm 63



20/23 Watt



LED bulb  
lampadina a LED

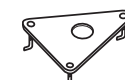
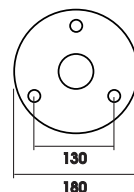

**Piastra**  
**fissaggio**  
**cod. APR8**





④  
**ART. 1762.T.AR**  
 H. 2700 - Larg. 1228

⑤  
**ART. 1763.T.AR**  
 H. 2700 - Larg. 1108

**.AR.BA=**  
 OTTONE ANTICIZZATO  
 LAITON VIEILLI  
 AGED BRASS  
 ANTIKISIERTER MESSING

**non teme la salsedine**  
**no problem with**  
**salt corrosion**

Colore vetri  
 Couleurs verres  
 Glass colors  
 Gläs farbe  
**.T = trasparente**  
**.O = opale**

CE IP 44 - E 27  
 Max Watt 52

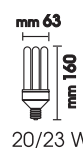

20/23 Watt

**CLASSE EFFICIENZA**  
**ENERGETICA**  
**energy efficiency classes**  
**A+ ÷ E**



LED bulb  
 lampadina a LED

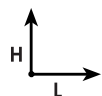





①

②

③

Ø 300

①

ART. 1340.T.BA  
H. 310 - Larg. 500 - Ø 300

②

ART. 1345.T.AR  
H. 340 - Larg. 360

③

ART. 1341.T.AR  
H. 340 - Larg. 540  
Inclinazione cappello 45°



.AR.BA=  
OTTONE ANTICIZZATO  
L'AITON VIEILLI  
AGED BRASS  
ANTIKISIERTER MESSING

**non teme la salsedine**  
**no problem with**  
**salt corrosion**

Colore vetri  
Couleurs verres  
Glass colors  
Gläs farbe  
.T = trasparente  
.O = opale

CE IP 44 - E 27

Max Watt 52

mm 63



20/23 Watt



LED bulb  
lampadina a LED

CLASSE EFFICIENZA ENERGETICA  
energy efficiency classes A+ ÷ E





④

Ø 300



⑤



⑥

④  
ART. 1343.T.AR  
H. 320 - Ø 300

⑤  
ART. 1344.T.AR  
H. 640 - Ø 300

⑥  
ART. 1342.T.AR  
H. 900 - Ø 300







①  
ART. 1628.AR  
H. 820 - Ø 300

②  
ART. 1629.AR  
H. min 600 - max 960  
Larg. 1020

③  
ART. 1627.BA  
H. 200 - Ø 300

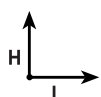

.AR.BA=  
OTTONE ANTICIZZATO  
LAITON VIEILLI  
AGED BRASS  
ANTIKISIERTER MESSING

**non teme la salsedine**  
**no problem with**  
**salt corrosion**

Cavo tessuto  
Cable tissue  
Câble tissu  
Kabel stuff

CE IP 20 - E 27

Max Watt 52



LED bulb  
lampadina a LED

CLASSE EFFICIENZA ENERGETICA  
energy efficiency classes A+ ÷ E

Estensione max. cm. 128

Estensione min. cm. 83





④

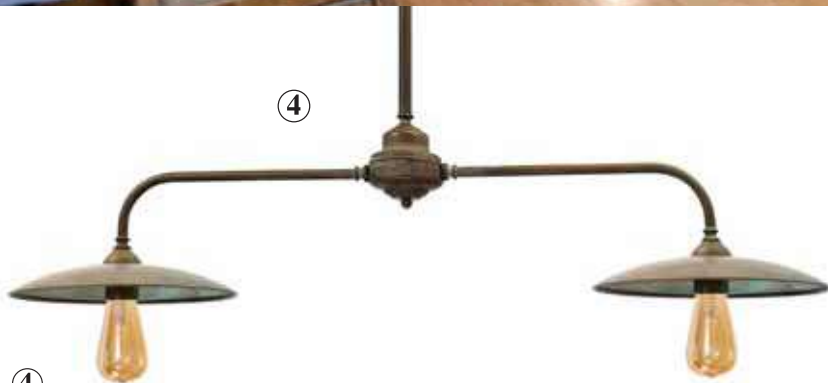

④

**ART. 1630.AR**

H. min 730 - max 1200 - Larg. 1113

⑤

**ART. 1631.AR**

H. min 820 - max 1250 - Larg. 1310

⑥

**ART. 1346.T.AR**

(con vetro/with glass)

**ART. 1346.AR**

(senza vetro/without glass)

① ② ④ ⑤ con  
with  
avec 

⑤

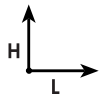

ART. 1620.BA



ART. 1621.AR



ART. 1622.AR



ART. 1623.AR



ART. 1624.AR



ART. 1626.AR

A RICHIESTA ANCHE CON VETRO / WITH GLASS TOO / AUSSI AVEC VERRE / AUCH MIT GLÄS **.T.O.**

**New**



ART. 1628R.AR



ART. 1628.3L.AR

**CE** IP 20 - E 27  
INDOOR LIGHTING

 Max Watt 52

  LED bulb  
lampadina a LED

CLASSE EFFICIENZA  
ENERGETICA A+ ÷ E  
energy efficiency classes





**New**

ART. 1628.5LAR



Art. RM1942

Ø 30

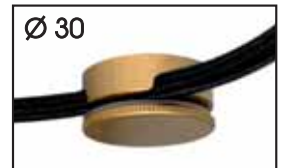

regolazione altezza incluso  
height adjustment included



Ø 310

Per 6 e più punti luce  
For 6 light and more

A RICHIESTA: cavo con lunghezza personalizzata e con più luci  
ON REQUEST: custom cable length or with more lights

1628.2LAR - 1628.4LAR - 1628.6LAR





①  
ART. 1750.T.AR  
H. 600 - Larg. 520

②  
ART. 1755.T.AR  
H. 1550 - Larg. 550

③  
ART. 1751.T.AR  
H. 2700 - Larg. 640



.AR.BA=  
OTTONE ANTICIZZATO  
LAITON VIEILLI  
AGED BRASS  
ANTIKISIERTER MESSING

**non teme la salsedine**  
**no problem with**  
**salt corrosion**

Colore vetri  
Couleurs verres  
Glass colors  
Gläs farbe  
.T = trasparente  
.O = opale

CE IP 44 - E 27

Max Watt 52

mm 63



20/23 Wat



LED bulb  
Lampadina a LED



**Piastra**  
**fissaggio**  
**cod. APR8**

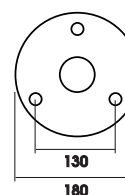

CLASSE EFFICIENZA ENERGETICA  
energy efficiency classes **A+ ÷ E**



④  
**ART. 1752.T.AR**  
 H. 2700 - Larg. 1228

⑤  
**ART. 1753.T.AR**  
 H. 2700 - Larg. 1108



**.AR.BA=**  
 OTTONE ANTICIZZATO  
 LAITON VIEILLI  
 AGED BRASS  
 ANTIKISIERTER MESSING

**non teme la salsedine**

**no problem with  
 salt corrosion**

Colore vetri  
 Couleurs verres  
 Glass colors  
 Gläs farbe

.T = trasparente

.O = opale

CE IP 44 - E 27  
 Max Watt 52



20/23 Watt



LED bulb  
 lampadina a LED

CLASSE EFFICIENZA ENERGETICA - energy efficiency classes **A+ ÷ E**





Ø 250

①  
ART. 1361.T.AR  
H. 300 - Larg. 470

②  
ART. 1360.T.AR  
H. 300 - Larg. 300

③  
ART. 1365.T.AR  
H. 330 - Larg. 510  
inclinazione cappello 45°



.AR.BA=  
OTTONE ANTICIZZATO  
LAITON VIEILLI  
AGED BRASS  
ANTIKISIERTER MESSING

**non teme la salsedine**  
**no problem with**  
**salt corrosion**

Colore vetri  
Couleurs verres  
Glass colors  
Gläs farbe  
.T = trasparente  
.O = opale

CE IP 44 - E 27

Max Watt 52



20/23 Watt



LED bulb  
lampadina a LED

CLASSE EFFICIENZA ENERGETICA  
energy efficiency classes A+ ÷ E





④

Ø 250



⑤



⑥

④  
ART. 1363.T.AR  
H. 290 - Ø 250

⑤  
ART. 1364.T.AR  
H. 620 - Ø 250

⑥  
ART. 1362.T.AR  
H. 850 - Ø 250







Ø 320

①  
ART. 1330.T.BA  
H. 330 - Larg. 520

②  
ART. 1335.T.AR  
H. 340 - Larg. 360

③  
ART. 1331.T.AR  
H. 370 - Larg. 590  
Inclinazione cappello 45°

**.AR.BA=**  
OTTONE ANTICHIZZATO  
L'AITON VIEILLI  
AGED BRASS  
ANTIKISIERTER MESSING  
**non teme la salsedine**  
**no problem with**  
**salt corrosion**

Colore vetri  
Couleurs verres  
Glass colors  
Gläs farbe  
.T = trasparente  
.O = opale

CE IP 44 - E 27

Light bulb icon Max Watt 52

mm 63  
mm 160  
Light bulb icon

20/23 Watt



LED bulb  
lampadina a LED



CLASSE EFFICIENZA ENERGETICA  
energy efficiency classes A+ ÷ E





④

④  
**ART. 1333.T.AR**  
 H. 320 - Ø 320



⑤

⑤  
**ART. 1334.T.AR**  
 H. 630 - Ø 320

Ø 320



⑥

**ART. 1332.T.AR** trasparente  
**ART. 1332.TO.AR** opale



⑦

**ART. 1332.TT.AR** trasparente  
**ART. 1332.TO.AR** opale

⑥  
**ART. 1332.T.AR**  
 H. 900 - Ø 320

⑦  
**ART. 1332.TT.AR**  
 H. 900 - Ø 320



Vetri disponibili in due forme diverse  
 Glasses available in two different shapes





①

Ø 320

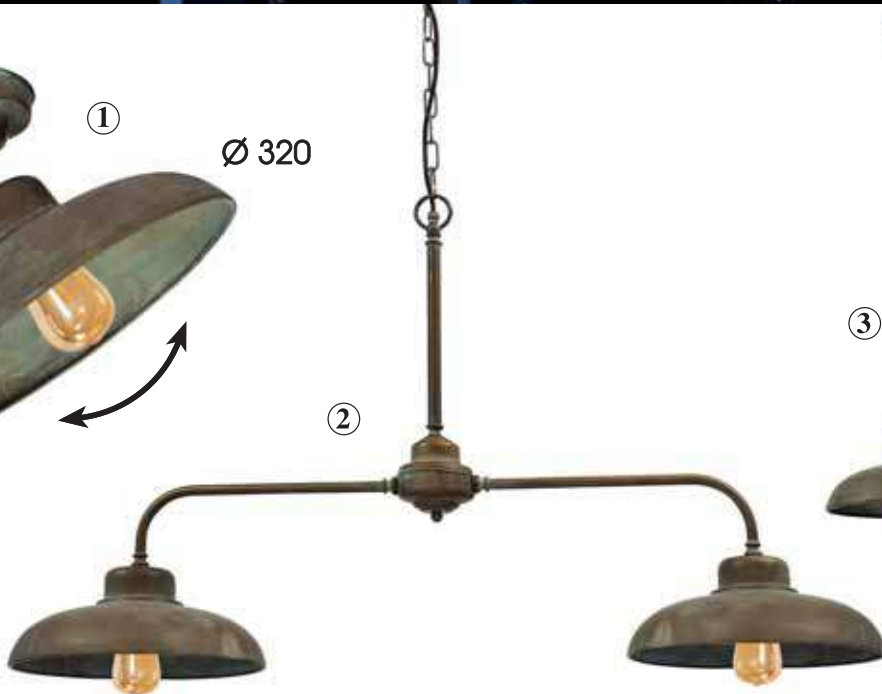

②

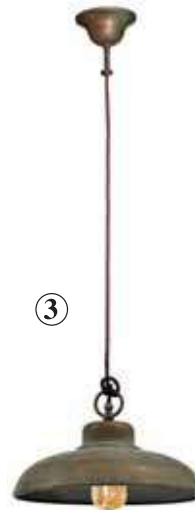

③

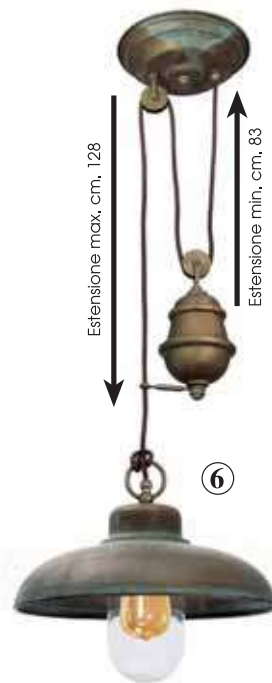

⑥

Estensione max. cm. 128

Estensione min. cm. 83

①

ART. 1656.AR  
H. 330 - Ø 320

②

ART. 1657.AR  
H. min 800 - max 1300  
Larg. 1100

③

ART. 1658.AR  
H. 830 - Ø 320



**.AR.BA=**  
OTTONE ANTICHIZZATO  
LAIION VIEILLI  
AGED BRASS  
ANTIKISIRTER MESSING

**non teme la salsedine**  
**no problem with**  
**salt corrosion**

Cavo tessuto  
Cable tissu  
Câble tissu  
Kabel stoff

CE IP 20 - E 27

⚡ Max Watt 52



CLASSE EFFICIENZA ENERGETICA  
energy efficiency classes **A+ ÷ E**



ART. 1650.AR



ART. 1651.BA

A RICHIESTA ANCHE CON VETRO / WITH GLASS TOO / AUSSI AVEC VERRE / AUCH MIT GLÄS **.T.O.**





Ø 320

④

**ART. 1660.BA**

H. min 600 - max 960  
Larg. 1020

⑤

**ART. 1659.BA**

H. min 820 - max 1250  
Larg. 1310

⑥

**ART. 1336.T.AR**  
(con vetro/with glass)

**ART. 1336.AR**  
(senza vetro/without glass)



ART. 1653.AR



ART. 1652.AR



ART. 1654.AR



ART. 1655.AR

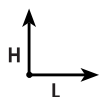

A RICHIESTA ANCHE CON VETRO / WITH GLASS TOO / AUSSI AVEC VERRE / AUCH MIT GLÄS T.O

**New**



ART. 1658R.AR



a richiesta / on request: .VS



ART. 1658.3L.AR



a richiesta / on request: .VS

CE IP 20 - E 27  
INDOOR LIGHTING

Max Watt 52



LED bulb  
lampadina a LED

CLASSE EFFICIENZA  
ENERGETICA A+ ÷ E  
energy efficiency classes





**New**



ART. 1658.5LAR



Ø 310

Per 6 e più punti luce  
For 6 light and more

Art. RM1942

Ø 30

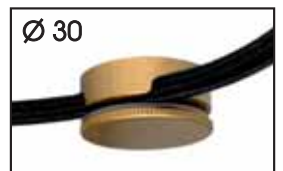

regolazione altezza incluso  
height adjustment included

A RICHIESTA: cavo con lunghezza personalizzata e con più luci  
ON REQUEST: custom cable length or with more lights

1658.2LAR - 1658.4LAR - 1658.6LAR

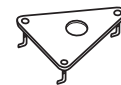

**Piastra  
fissaggio  
cod. APR8**

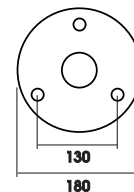

- ①  
**ART. 1770.T.AR**  
H. 600 - Larg. 520
- ②  
**ART. 1775.T.AR**  
H. 1550 - Larg. 560
- ③  
**ART. 1771.T.AR**  
H. 2700 - Larg. 640



**.AR.BA=**  
OTTONE ANTICIZZATO  
LAITON VIEILLI  
AGED BRASS  
ANTIKISIERTER MESSING  
**non teme la salsedine**  
**no problem with**  
**salt corrosion**  
Colore vetri  
Couleurs verres  
Glass colors  
Gläs farbe  
.T = trasparente  
.O = opale

**CE** IP 44 - E 27

Light bulb icon Max Watt 52

mm 63



20/23 Wat



LED bulb  
lampadina a LED

**CLASSE EFFICIENZA ENERGETICA**  
**energy efficiency classes** **A+ ÷ E**





④  
**ART. 1772.T.AR**  
 H. 2700 - Larg. 1230

⑤  
**ART. 1773.T.AR**  
 H. 2700 - Larg. 1110

**.AR.BA=**  
 OTTONE ANTICIZZATO  
 LAITON VIEILLI  
 AGED BRASS  
 ANTIKISIERTER MESSING

**non teme la salsedine**  
**no problem with**  
**salt corrosion**

Colore vetri  
 Couleurs verres  
 Glass colors  
 Gläs farbe  
**.T = trasparente**  
**.O = opale**

CE IP 44 - E 27

Max Watt 52



20/23 Watt

**CLASSE EFFICIENZA**  
**ENERGETICA**  
 energy efficiency classes  
**A+ ÷ E**



LED bulb  
 lampadina a LED

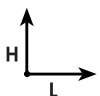





**New**



PRIMA / BEFORE

ADESSO / NOW

①  
ART. 2050.AR  
H. 270 - Larg. 260  
IP 44

②  
ART. 2051.AR  
H. 280 - Larg. 320  
IP 44

③  
ART. 2052.AR  
H. 340 - Larg. 215  
IP 44

④  
ART. 2053.AR  
H. 930 - Larg. 215  
IP 44

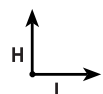

Ø 215



⑤

**ART. 2055.AR**  
H. 470 - Larg. 215

⑥

**ART. 2056.AR**  
H. 1070 - Larg. 215

⑦

**ART. 2057.AR**  
H. 1770 - Larg. 215

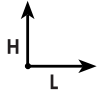

CE IP 43 - E 27

Max Watt 52

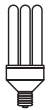

20/23 Watt



LED bulb  
lampadina a LED

**CLASSE  
EFFICENZA  
ENERGETICA  
A+ ÷ E**

**.AR.AC.BA=**

OTTONE ANTICIZZATO  
PER ESTERNI E INTERNI

AGED BRASS FOR  
OUTDOOR AND INDOOR

LAITON VIEILLI

ANTIKISIERTER MESSING

**non teme la salsedine  
no problem with  
salt corrosion**

Colore vetri: trasparente  
Couleurs verres: transparent  
Glass colors: clear



Ø 215

base Ø 140



⑤



⑥

⑦



**New**



PRIMA / BEFORE

ADESSO / NOW

①  
ART. 2060.AR  
H. 290 - Larg. 250  
IP 44

②  
ART. 2061.AR  
H. 280 - Larg. 320  
IP 44

③  
ART. 2062.AR  
H. 340 - Larg. 225  
IP 44

④  
ART. 2063.AR  
H. 930 - Larg. 225  
IP 44

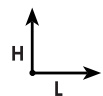



⑤

ART. 2064.AR  
H. 480 - Larg. 225

⑥

ART. 2065.AR  
H. 1080 - Larg. 225

⑦

ART. 2066.AR  
H. 1780 - Larg. 225



CE IP 43 - E 27

Max Watt 52



20/23 Watt



LED bulb  
lampadina a LED

**CLASSE  
EFFICENZA  
ENERGETICA  
A+ ÷ E**

**.AR.AC.BA=**

OTTONE ANTICIZZATO  
PER ESTERNI E INTERNI

AGED BRASS FOR  
OUTDOOR AND INDOOR

LAITON VIEILLI

ANTIKISIERTER MESSING

**non teme la salsedine  
no problem with  
salt corrosion**

Colore vetri: trasparente  
Couleurs verres: transparent  
Glass colors: clear



Ø 225



base Ø 140



⑤



⑥

⑦



**New**



PRIMA / BEFORE

ADESSO / NOW

①

ART. 2070.AR  
H. 300 - Larg. 290  
IP 44

②

ART. 2071.AR  
H. 280 - Larg. 320  
IP 44

③

ART. 2072.AR  
H. 950 - Larg. 260  
IP 44

④

ART. 2073.AR  
H. 340 - Larg. 260  
IP 44



Ø 260



5

ART. 2074.AR  
H. 510 - Larg. 260

6

ART. 2075.AR  
H. 1100 - Larg. 260

7

ART. 2076.AR  
H. 1800 - Larg. 260

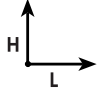

CE IP 43 - E 27

Max Watt 52



20/23 Watt

LED bulb  
lampadina a LED

**CLASSE  
EFFICENZA  
ENERGETICA  
A+ ÷ E**

.AR.AC.BA=

OTTONE ANTICIZZATO  
PER ESTERNI E INTERNI

AGED BRASS FOR  
OUTDOOR AND INDOOR

LAITON VIEILLI

ANTIKISIERTER MESSING

**non teme la salsedine  
no problem with  
salt corrosion**

Colore vetri: trasparente  
Couleurs verres: transparent  
Glass colors: clear



Ø 260



base Ø 140



5



6

7





**New**



PRIMA / BEFORE

ADESSO / NOW

①

**ART. 2080.AR**  
H. 310 - Larg. 260  
IP 44

②

**ART. 2081.AR**  
H. 280 - Larg. 320  
IP 44

③

**ART. 2082.AR**  
H. 970 - Larg. 215  
IP 44

④

**ART. 2083.AR**  
H. 380 - Larg. 215  
IP 44



Ø 215



⑤

ART. 2084.AR  
H. 510 - Larg. 215

⑥

ART. 2085.AR  
H. 1100 - Larg. 215

⑦

ART. 2086.AR  
H. 1800 - Larg. 215

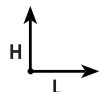

CE IP 43 - E 27

Max Watt 52



20/23 Watt

LED bulb  
lampadina a LED

**CLASSE  
EFFICENZA  
ENERGETICA  
A+ ÷ E**

**.AR.AC.BA=**

OTTONE ANTICIZZATO  
PER ESTERNI E INTERNI

AGED BRASS FOR  
OUTDOOR AND INDOOR

LAITON VIEILLI

ANTIKISIERTER MESSING

**non teme la salsedine  
no problem with  
salt corrosion**

Colore vetri: trasparente  
Couleurs verres: transparent  
Glass colors: clear



Ø 215



base Ø 140



⑤



⑥

⑦



①  
ART. 133.O.AR  
H. 260 - Larg. 260

②  
ART. 161.T.AR  
H. 260 - Larg. 320

③  
ART. 162.T.AR  
H. 920 - Larg. 215

④  
ART. 162.F.T.AR  
H. 330 - Larg. 215

⑤  
ART. 139.T.AR  
H. 290 - Larg. 380

**.AR.BA=**  
OTTONE ANTICIZZATO  
PER ESTERNI E INTERNI  
AGED BRASS FOR  
OUTDOOR AND INDOOR  
LAITON VIEILLI  
ANTI-KISIERTER MESSING

**non teme la salsedine  
no problem with  
salt corrosion**

Colore vetri  
Couleurs verres  
Glass colors  
Gläs farbe  
.T = trasparente  
.O = opale

**CLASSE EFFICIENZA  
ENERGETICA**  
energy efficiency classes  
**A+ ÷ E**

CE IP 44 - E 27  
Max Watt 52

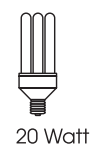

20 Watt



LED bulb  
lampadina a LED







①  
ART. 134.O.AR  
H. 260 - Larg. 260

②  
ART. 163.T.AR  
H. 280 - Larg. 320

③  
ART. 164.T.AR  
H. 920 - Larg. 215

④  
ART. 164F.T.AR  
H. 330 - Larg. 215

⑤  
ART. 140.O.AR  
H. 290 - Larg. 380

.AR.BA=  
OTTONE ANTICIZZATO  
PER ESTERNI E INTERNI  
AGED BRASS FOR  
OUTDOOR AND INDOOR  
LAITON VIEILLI  
ANTIKISIERTER MESSING

**non teme la salsedine  
no problem with  
salt corrosion**

Colore vetri  
Couleurs verres  
Glass colors  
Gläs farbe  
.T = trasparente  
.O = opale

CLASSE EFFICIENZA  
ENERGETICA  
energy efficiency classes  
A+ ÷ E

CE IP 44 - E 27  
Max Watt 52



20 Watt  
LED bulb  
lampadina a LED

Ø 215





①  
ART. 125.O.AR  
H. 280 - Larg. 350

②  
ART. 126.O.AR  
H. 300 - Larg. 320

③  
ART. 127.O.AR  
H. 900 - Larg. 250

④  
ART. 128.O.AR  
H. 350 - Larg. 490

⑤  
ART. 129.O.AR  
H. 320 - Larg. 250

.AR.BA=

OTTONE ANTICIZZATO  
PER ESTERNI E INTERNI

AGED BRASS FOR  
OUTDOOR AND INDOOR

LAITON VIEILLI

ANTIKISIERTER MESSING

**non teme la salsedine**

**no problem with  
salt corrosion**

Colore vetri  
Couleurs verres  
Glass colors  
Gläs farbe

.T = trasparente

.O = opale

**CLASSE EFFICIENZA  
ENERGETICA**  
energy efficiency classes  
**A+ ÷ E**

CE IP 44 - E 27

Max Watt 52



20 Watt



LED bulb  
lampadina a LED





Ø 110



①  
ART. 1970.O.AR  
H. 290 - Larg. 380

②  
ART. 1971.O.AR  
H. 270 - Larg. 420

③  
ART. 1972.O.AR  
H. 870 - Ø 22

④  
ART. 1973.O.AR  
H. 300 - Larg. 220



.AR.AC.BA.NA=  
OTTONE ANTICIZZATO PER ESTERNI E INTERNI  
AGED BRASS FOR OUTDOOR AND INDOOR  
LAIION VIEILLI  
ANTI KISIERTER MESSING

**non teme la salsedine**  
**no problem with**  
**salt corrosion**

Finitura ottone per Interni  
Indoor brass finishes  
.A.A.R.A.C.B.A.D.N.A

Colore vetri  
Couleurs verres  
Glass colors  
Gläs farbe  
.T = trasparente  
.O = opale

CE IP 44 - E 27  
Max Watt 52



20/23 Watt

CLASSE EFFICIENZA  
ENERGETICA  
energy efficiency classes  
A+ ÷ E



LED bulb  
lampadina a LED





①  
**ART. 2090.T.AR**  
H. 350 - Larg. 330

②  
**ART. 2091.T.AR**  
H. 400 - Larg. 400

③  
**ART. 2092.T.AR**  
H. 310 - Larg. 370

④  
**ART. 2093.T.AR**  
H. 420 - Larg. 490





Ø 110



Ø 285



⑤  
ART. 2094.T.AR  
H. 900 - Larg. 285

⑥  
ART. 2095.T.AR  
H. 340 - Larg. 285

.AR.BA=  
OTTONE ANTICIZZATO  
PER ESTERNI E INTERNI  
AGED BRASS FOR  
OUTDOOR AND INDOOR  
LAITON VIEILLI  
ANTIKISIERTER MESSING

**non teme la salsedine  
no problem with  
salt corrosion**

Colore vetri  
Couleurs verres  
Glass colors  
Gläs farbe  
.T = trasparente  
.O = opale

CLASSE EFFICIENZA  
ENERGETICA  
energy efficiency classes  
A+ ÷ E

CE IP 44 - E 27  
Max Watt 52



20 Watt



LED bulb  
lampadina a LED







①

Ø 285



②

205



③

205

①

ART. 1790.T.AR  
H. 600 - Larg. 520

②

ART. 1794.T.AR  
H. 1550 - Larg. 548

③

ART. 1791.T.AR  
H. 2700 - Larg. 638



**.AR.BA=**

OTTONE ANTICIZZATO  
LATON VIEILLI  
AGED BRASS  
ANTIKISIERTER MESSING

**non teme la salsedine**  
**no problem with**  
**salt corrosion**

Colore vetri  
Couleurs verres  
Glass colors  
Gläs farbe  
.T = trasparente  
.O = opale

**CLASSE EFFICIENZA**  
**ENERGETICA**  
**energy efficiency classes**

**A+ ÷ E**

CE IP 44 - E 27

Max Watt 52

mm 63



20/23 Watt



LED bulb  
lampadina a LED

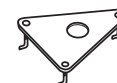
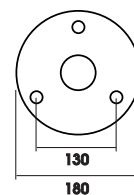

**Piastra**  
**fissaggio**  
**cod. APR8**





④  
**ART. 1792.T.AR**  
 H. 2700 - Larg. 1226

⑤  
**ART. 1793.T.AR**  
 H. 2700 - Larg. 1106



**.AR.BA=**  
 OTTONE ANTICHIZZATO  
 LAITON VIEILLI  
 AGED BRASS  
 ANTIKISIERTER MESSING

**non teme la salsedine**  
**no problem with**  
**salt corrosion**

Colore vetri  
 Couleurs verres  
 Glass colors  
 Gläs farbe  
 .T = trasparente  
 .O = opale

CE IP 44 - E 27  
 Max Watt 52



20/23 Watt



LED bulb  
 lampadina a LED

CLASSE EFFICIENZA ENERGETICA - energy efficiency classes **A+ ÷ E**

# Casale

Ø 110



ART. 809.O.AR



ART. 993.T.AR

.AR.BA=

OTTONE ANTICIZZATO  
PER ESTERNI E INTERNI

AGED BRASS FOR  
OUTDOOR AND INDOOR

LAITON VIEILLI

ANTIKISIERTER MESSING

**non teme la salsedine**  
**no problem with**  
**salt corrosion**

Colore vetri  
Couleurs verres  
Glass colors  
Gläs farbe

.T = trasparente

.O = opale

**CLASSE EFFICIENZA  
ENERGETICA**  
energy efficiency classes  
**A+ ÷ E**

CE IP 44 - E 27

Max Watt 52



LED bulb  
lampadina a LED

Ø 110



ART. 994.T.AR



ART. 994F.T.AR



ART. 809.T.AR



ART. 994F.O.AR

*Casale*



# Casale

## CERAMICA

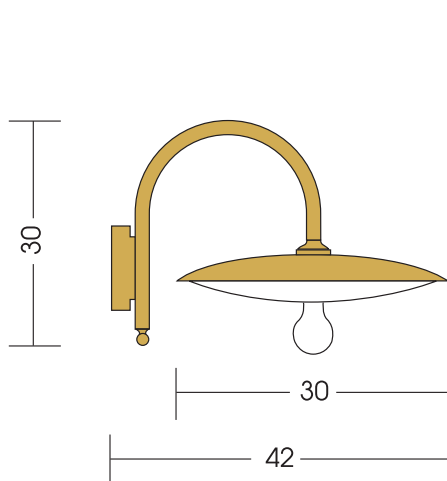

ART. 805P

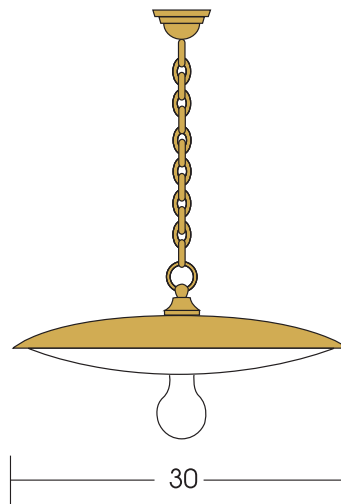

ART. 806P

IP 23   E 27  Max Watt 52

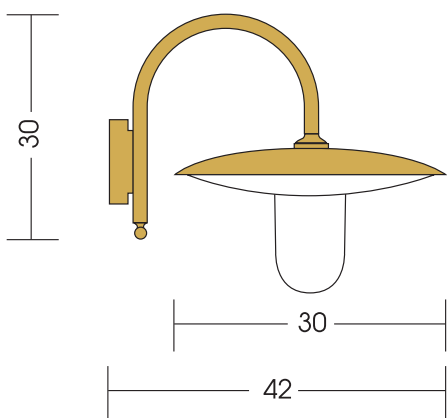

ART. 993P.O  
ART. 993P.T

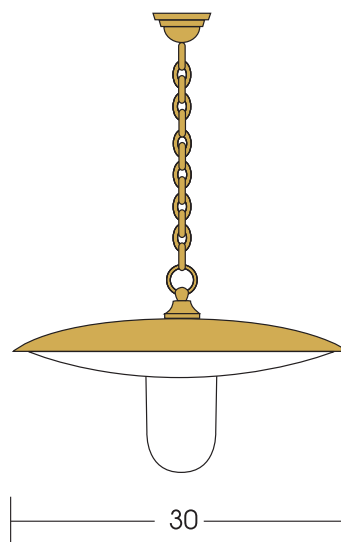

ART. 994P.O  
ART. 994P.T

**.AR.BA=**

OTTONE ANTICIZZATO  
PER ESTERNI E INTERNI  
AGED BRASS FOR  
OUTDOOR AND INDOOR  
LAITON VIEILLI  
ANTIKISIERTER MESSING

**non teme la salsedine  
no problem with  
salt corrosion**

Colore vetri  
Couleurs verres  
Glass colors  
Glás farbe  
.T = trasparente  
.O = opale

**CLASSE EFFICIENZA  
ENERGETICA**  
energy efficiency classes

**A+ ÷ E**

 IP 44 - E 27

 Max Watt 52



LED bulb  
lampadina a LED



ART. 994P.A.O



ART. 805P.AR

*Casale*



ART. 200.09.T



ART. 200.09.O



ART. 200.09.O.AR



AR = Ottone antichizzato ramato

①  
ART. 200.09  
H. 225 - Larg. 150





②

ART. 203

H. 420 - Larg. 270

③

ART. 204

H. 420 - Larg. 430

④

ART. 205

H. 1050 - Larg. 270

⑤

ART. 206

H. 1050 - Larg. 430



CE IP 44 - E 27

Max Watt 52



LED bulb  
lampadina a LED

**CLASSE  
EFFICENZA  
ENERGETICA  
A+ ÷ E**

ART. 200.09

natural brass color

.AR.AC.BA=

OTTONE ANTICIZZATO  
PER ESTERNI E INTERNI

AGED BRASS FOR  
OUTDOOR AND INDOOR

LAITON VIEILLI

ANTIKISIERTER MESSING

**non teme la salsedine  
no problem with  
salt corrosion**

Colore vetri  
Couleurs verres  
Glass colors  
Gläs farbe

.T = trasparente

.O = opale

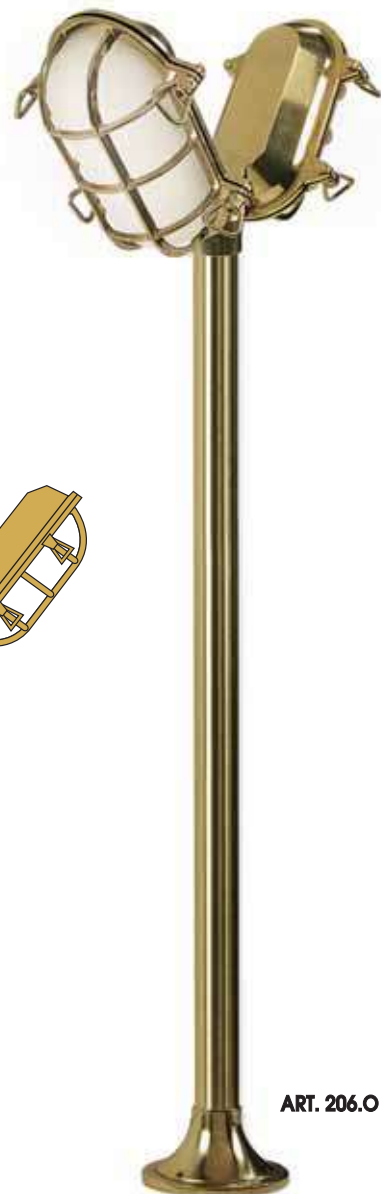

ART. 206.O

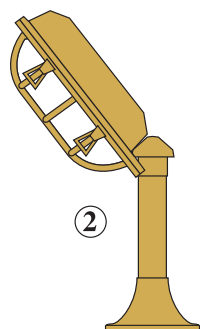

②

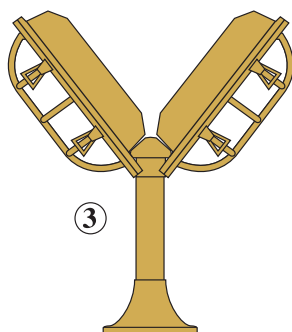

③

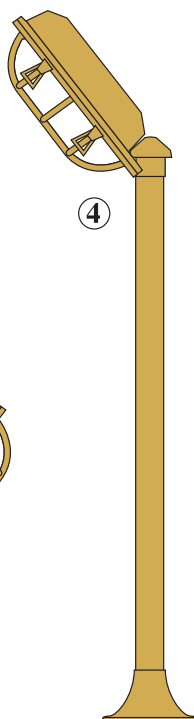

④

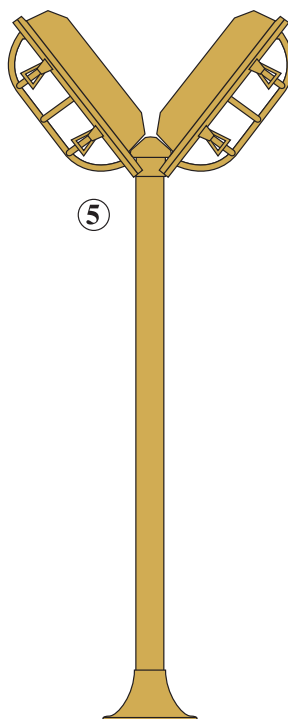

⑤



ART. 200.15.T



ART. 200.15.O



ART. 200.15.T.AR



ART. 200.15.O.AR

**ART. 200.15**  
natural brass color

**.AR.BA=**

OTTONE ANTICIZZATO  
PER ESTERNI E INTERNI  
AGED BRASS FOR  
OUTDOOR AND INDOOR  
LATON VIEILLI  
ANTIKISERTER MESSING

**non teme la salsedine**  
**no problem with**  
**salt corrosion**

Colore vetri  
Couleurs verres  
Glass colors  
Gläs farbe  
.T = trasparente  
.O = opale

CE IP 44 - E 27  
Max Watt 52



LED bulb  
lampadina a LED

**CLASSE  
EFFICENZA  
ENERGETICA  
A+ ÷ E**





115

Ø 175



①

ART. 200.14.T.AR

ART. 200.14.O.AR



ART. 200.14.O



ART. 200.14.T

①

ART. 200.14.O  
Ø 175  
natural brass color

CE IP 44 - E 27  
Max Watt 52



LED bulb  
lampadina a LED

.AR.BA=

OTTONE ANTICIZZATO  
PER ESTERNI E INTERNI  
AGED BRASS FOR  
OUTDOOR AND INDOOR  
LAIION VIEILLI  
ANTIKISIERTER MESSING

**non teme la salsedine**  
**no problem with**  
**salt corrosion**

Colore vetri  
Couleurs verres  
Glass colors  
Gläs farbe  
.T = trasparente  
.O = opale

**CLASSE  
EFFICENZA  
ENERGETICA  
A+ ÷ E**





110

Ø 210



ART. 200.10.O



①

ART. 200.10.T



ART. 200.10.O.AR

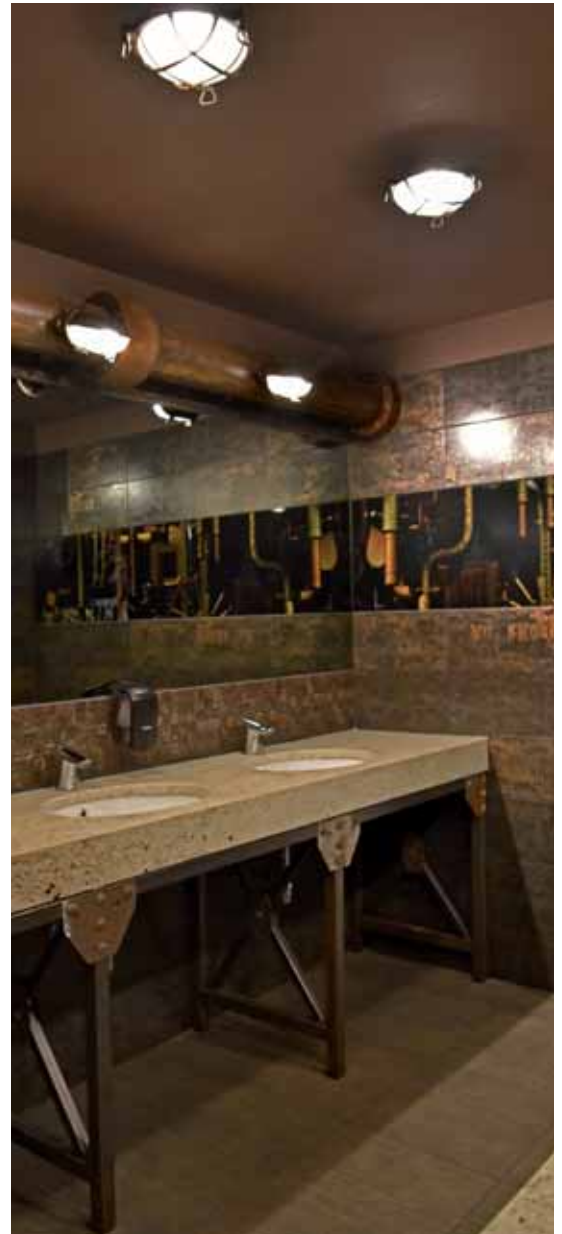

①  
ART. 200.10.T  
Ø 210  
natural brass color

②

ART. 216

H. 410 - Larg. 260

③

ART. 217

H. 410 - Larg. 400

④

ART. 218

H. 1030 - Larg. 260

⑤

ART. 219.O

H. 1030 - Larg. 400



CE IP 44 - E 27

Max Watt 52



LED bulb  
lampadina a LED

**CLASSE  
EFFICENZA  
ENERGETICA  
A+ ÷ E**

ART. 200.10

natural brass color

.AR.AC.BA=

OTTONE ANTICIZZATO  
PER ESTERNI E INTERNI

AGED BRASS FOR  
OUTDOOR AND INDOOR

LATON VIEILLI

ANTIKISIERTER MESSING

**non teme la salsedine  
no problem with  
salt corrosion**

Colore vetri

Couleurs verres

Glass colors

Gläs farbe

.T = trasparente

.O = opale

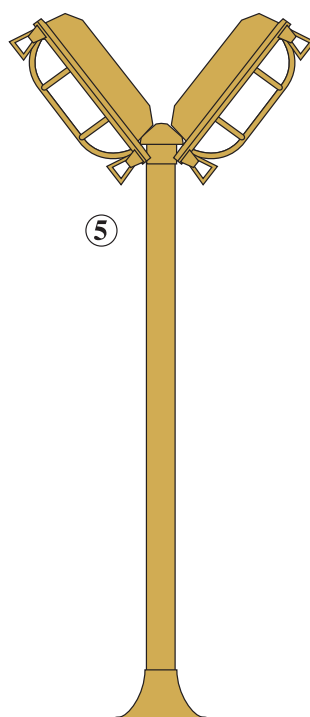
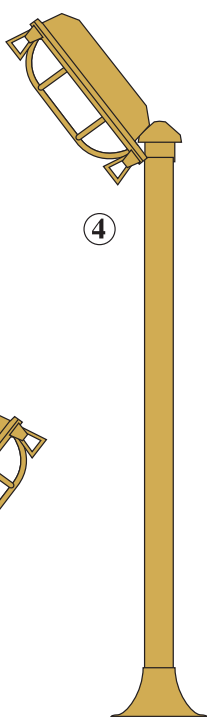
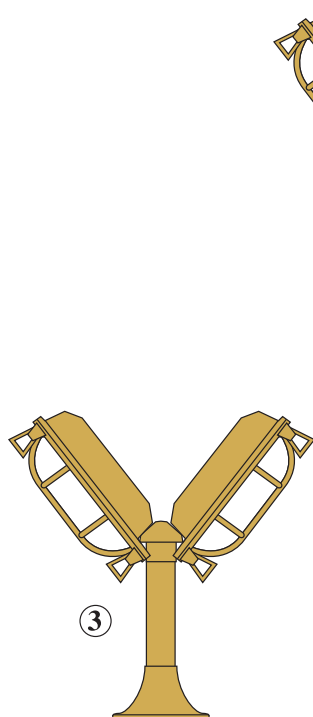
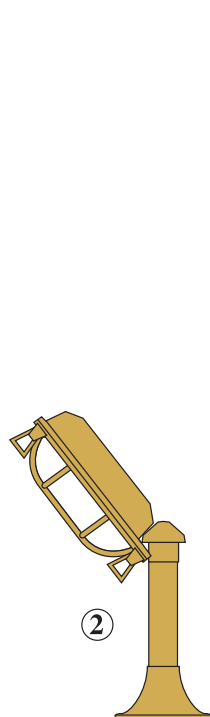
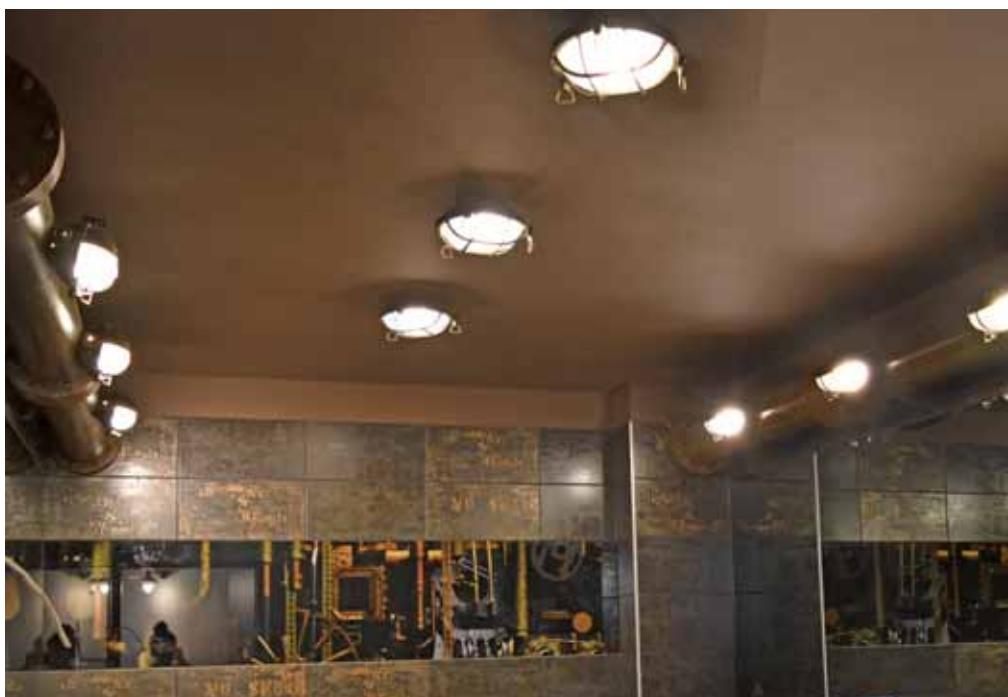



①  
**ART. 180**  
H. 270 - Larg. 210

②  
**ART. 181.AR**  
H. 210 - Larg. 170

③  
**ART. 182**  
H. 330 - Larg. 145





③  
**ART. 183.AR**  
H. 400 - base Larg. 110

④  
**ART. 184.AR**  
H. 1030 - base Larg. 110

⑤  
**ART. 183**  
H. 400 - base Larg. 110

⑥  
**ART. 184**  
H. 1030 - base Larg. 110



CE IP 44 - E 27

Max Watt 52



23/25 Watt

LED bulb  
lampadina a LED

**CLASSE  
EFFICENZA  
ENERGETICA  
A+ ÷ E**

**.AR.BA=**

OTTONE ANTICIZZATO  
PER ESTERNI E INTERNI

AGED BRASS FOR  
OUTDOOR AND INDOOR

LAITON VIEILLI

ANTIKISIERTER MESSING

**non teme la salsedine  
no problem with  
salt corrosion**

Colore vetri  
Couleurs verres  
Glass colors  
Glás farbe

**.T = trasparente prismato**



③



④



⑤



⑥

ART. 186



ART. 186.AR

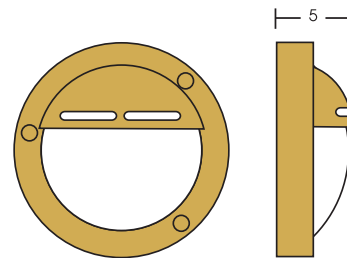

ART. 186.Gx53  
ART. 186.G9  
H. 5 - Prof. 5 - Ø 14 - G9 25 Watt

**MICRO-LYNX F**

GX53= lampadina con dimensioni massime

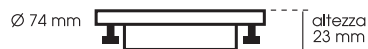

esempio con lampadina sylvania 6W - Art. 25214

IP 44

Art. 185/186/187/188 - VETRO: Opale liscio - VERRE: Blanc - GLASS: White

CLASSE EFFICIENZA ENERGETICA  
energy efficiency classes



G9  
1x25

B ÷ F



GX53  
1x6 W  
GX53

A ÷ B



**MICRO-LYNX F**  
GX53= lampadina con dimensioni massime

Ø 74 mm altezza 23 mm

esempio con lampadina sylvania 6W - Art. 25214

IP 44

Art. 185/186/187/188 - VETRO: Opale liscio - VERRE: Blanc - GLASS: White

**CLASSE EFFICIENZA ENERGETICA**  
energy efficiency classes

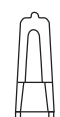

**G9**  
1x25

B ÷ F



**GX53**  
1x6 W  
GX53

A ÷ B



# Silver ocean

( OTTONE NICHELATO )

PLAFONIERE PER ESTERNI / LUMINAIRES POUR EXTÉRIEUR / OUTDOOR LIGHTING  
DECKENLAMPE FÜR DEN AUßENRAUM

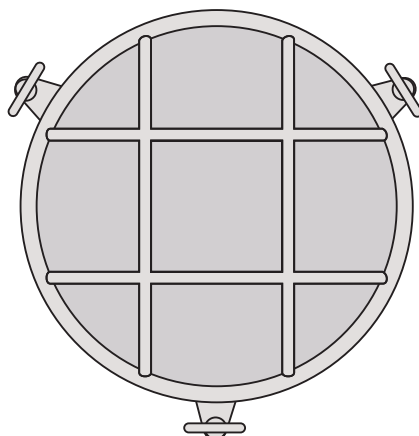

ART. 200.20  
Larg. 21

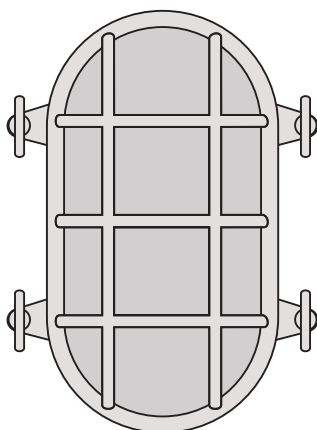

ART. 200.21  
Larg. 15 - H. 22,5

CORPO: Ottone - CORPS: Laiton - BODY: Brass - KÖRPER: Messing  
COLORE: Argento - COULEUR: Argent - COLOR: Silver - FARBE: Silbern  
VETRO: Opale o trasparente - VERRE: Blanc ou transparent - GLASS: White or transparent  
MILCHGLAS: Oder transparentes Glas

 18 W Genie ( 200.20 e 200.21 ) - IP 44

 E 27

 Max Watt 52



LED bulb  
lampadina a LED

**CLASSE EFFICIENZA  
ENERGETICA**  
energy efficiency classes  
**A+ ÷ E**



ART. 200.21  
Larg. 15 - H. 22,5



ART. 200.20  
Larg. 21





Lampada da parete  
Wall lamp  
Wandlampe  
Applique

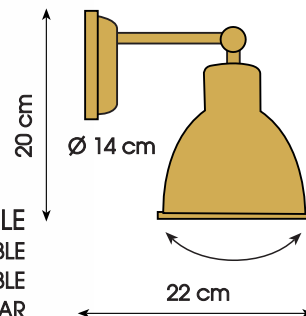

ORIENTABILE  
ORIENTABLE  
ADJUSTABLE  
EINSTERLLBAR

ART. 3010.AR Ø 15 cm



ART. 3011.AR



ART. 3012.AR

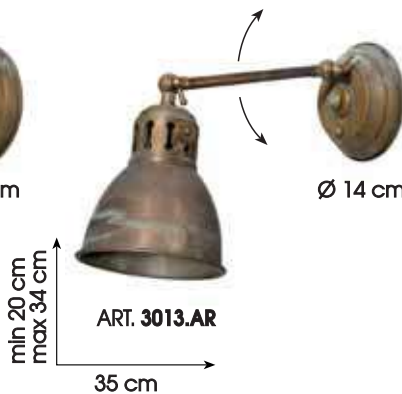

ART. 3013.AR



ART. 3014.AR

Colori ottone/Couleurs laiton/Brass colors/Messing farbe

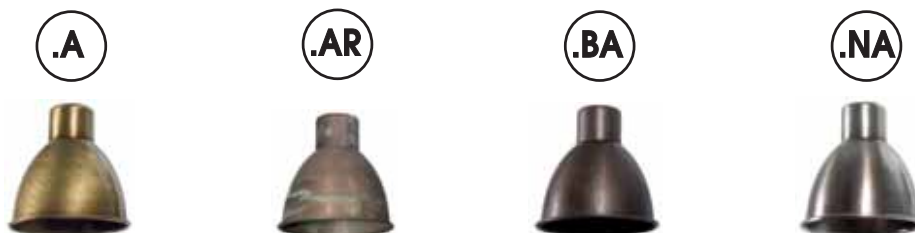

.A.AR.BA.NA= OTTONE ANTICHIZZATO / AGED BRASS / LAITON VIEILLI / ANTIKISIERTER MESSING

CE IP 20 - E 27

Max Watt 52

20/23 Watt

LED bulb  
lampadina a LED

CLASSE EFFICIENZA  
ENERGETICA A+ ÷ E  
energy efficiency classes





**New**

Art. RM1942

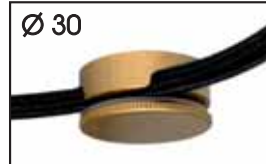

regolazione altezza incluso  
hight adjustment included

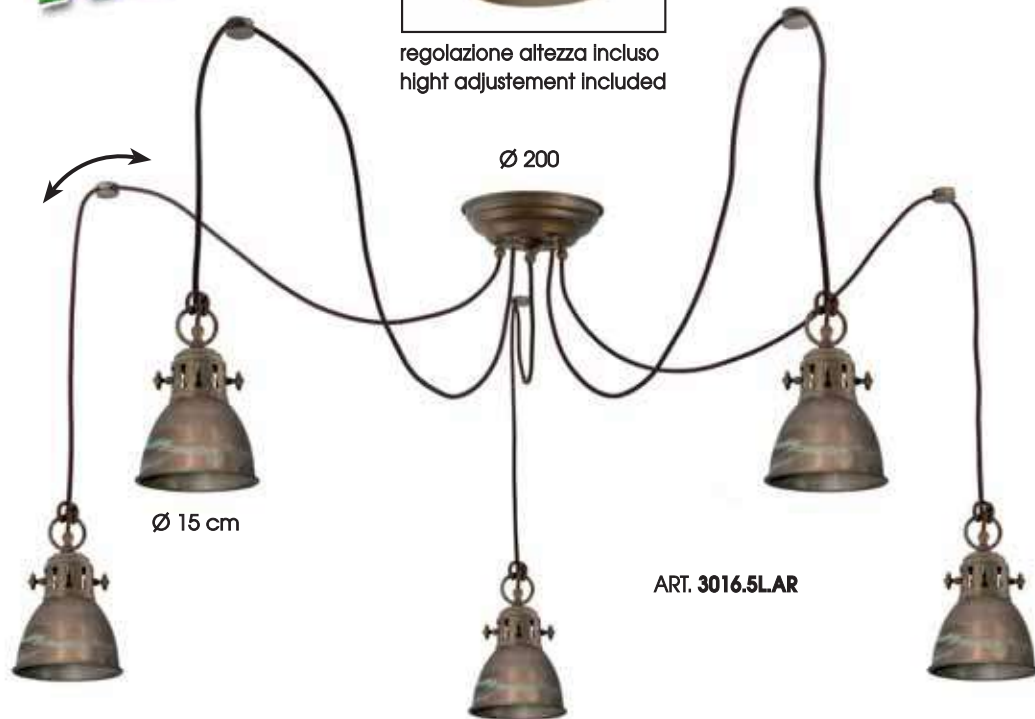

A RICHIESTA: cavo con lunghezza personalizzata e con più luci  
ON REQUEST: custom cable length or with more lights

3016.2L - 3016.3L - 3016.4L - 3016.6L - 3016.7L - 3016.8L - 3016.9L - 3016.10L



Per 6 e più punti luce  
For 6 light and more

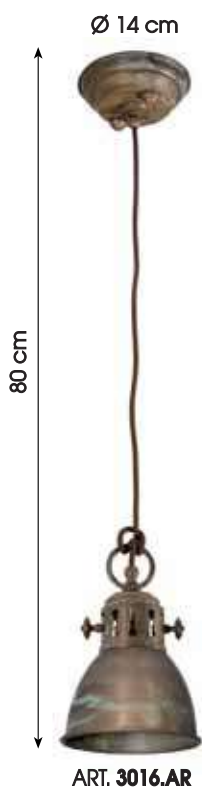

OTTONE ANTICIZZATO  
AGED BRASS / LAITON VIEILLI / ANTIKISIERTER MESSING

Ø 14 cm

**.AR**



ART. 3020.AR.6



ART. 3020.AR.7



ART. 3020.AR.8

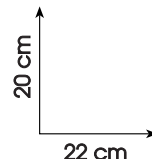

**.AR**



ART. 3021.AR.6



ART. 3021.AR.7



ART. 3021.AR.8

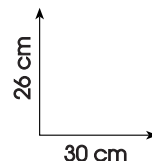

**.AR**



ART. 3022.AR.6



ART. 3022.AR.7



ART. 3022.AR.8

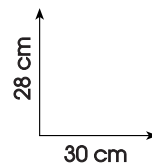

**.AR**



ART. 3023.AR.6



ART. 3023.AR.7



ART. 3023.AR.8

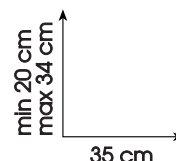

○ .6 = bianco/white

● .7 = ambra/amber

● .8 = verde/green

Colore vetri / Couleurs des opallines / Glass colors / Gläs farbe

Colori ottone/Couleurs laiton/Brass colors/Messing farbe

**.A**



**.AR**



**.BA**



**.NA**



**.A.AR.BA.NA=** OTTONE ANTICIZZATO / AGED BRASS / LAITON VIEILLI / ANTIKISIERTER MESSING

CE IP 20 - E 27

Max Watt 52

20/23 Watt

LED bulb  
lampadina a LED

CLASSE EFFICIENZA  
ENERGETICA A+ ÷ E  
energy efficiency classes



Lampada da tavolo  
Table lamp  
Tischlampe  
Lampe de table



ART. 3024.AR.7 Ø 15 cm

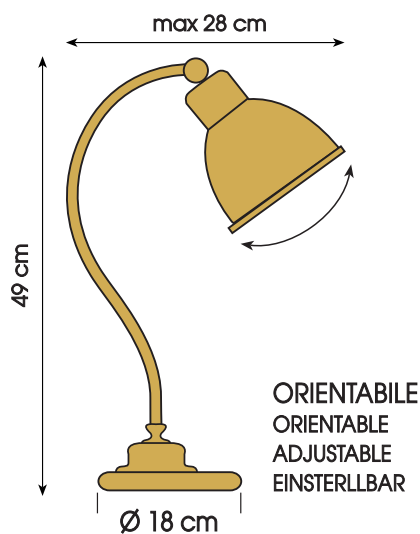

ART. 3024.AR.6



ART. 3024.AR.7



ART. 3024.AR.8

○ .6 = bianco/white

● .7 = ambra/amber

● .8 = verde/green

Colore vetri / Couleurs des opallines / Glass colors / Gläs farbe



OTTONE ANTICIZZATO  
AGED BRASS / LAITON VIEILLI / ANTIKISIERTER MESSING

Ø 20 cm

.AR



ART. 3025.AR.6



ART. 3025.AR.7



ART. 3025.AR.8

30 cm  
63 cm

.AR



ART. 3026.AR.6



ART. 3026.AR.7



ART. 3026.AR.8

Ø 14 cm

80 cm

.AR



ART. 3027.AR.6



ART. 3027.AR.7



ART. 3027.AR.8

Ø 26 cm

62 cm

.AR



ART. 3028.AR.6



ART. 3028.AR.7



ART. 3028.AR.8

Ø 26 cm

82 cm

○ .6 = bianco/white

● .7 = ambra/amber

● .8 = verde/green

Colore vetri / Couleurs des opallnes / Glass colors / Gläs farbe

Colori ottone/Couleurs laiton/Brass colors/Messing farbe

.A



.AR



.BA



.NA



.A.AR.BA.NA= OTTONE ANTICIZZATO / AGED BRASS / LAITON VIEILLI / ANTIKISIERTER MESSING

CE IP 20 - E 27

Max Watt 52

20/23 Watt

LED bulb  
lampadina a LED

CLASSE EFFICIENZA  
ENERGETICA A+ ÷ E  
energy efficiency classes



Lampadario 3 luci  
Ceiling lamp  
Aufhängung  
Suspension



ART. 3025.AR.8

Ø 15 cm



ART. 3026.AR.6



ART. 3027.AR.7



ART. 3028.AR.8

**New**



Per 6 e più punti luce  
For 6 light and more

A RICHIESTA: cavo con lunghezza personalizzata e con più luci  
ON REQUEST: custom cable length or with more lights

3026.2L - 3026.3L - 3026.4L - 3026.6L - 3026.7L - 3026.8L - 3026.9L - 3026.10L



○ .6 = bianco/white

● .7 = ambra/amber

● .8 = verde/green

Colore vetri / Couleurs des opalines / Glass colors / Gläs farbe

CE IP 20 - E 27

Max Watt 52

20/23 Watt

LED bulb  
lampadina a LED

CLASSE EFFICIENZA  
ENERGETICA A+ ÷ E  
energy efficiency classes





Art. RM1942

Ø 30

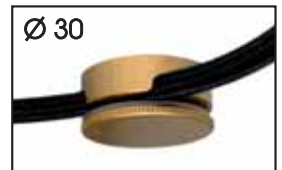

regolazione altezza incluso  
high adjustment included

ART. 3026.5L.AR.7

Ø 200



Ø 310



Per 6 e più punti luce  
For 6 light and more

A RICHIESTA: cavo con lunghezza personalizzata e con più luci  
ON REQUEST: custom cable length or with more lights

○ .6 = bianco/white

● .7 = ambra/amber

● .8 = verde/green

Colore vetri / Couleurs des opallnes / Glass colors / Gläs farbe





lampade da parete  
wall lamp

lampade da tavolo  
table lamp

lampadari  
ceiling lamp





Lampada da parete  
Wall lamp  
Wandlampe  
Applique



Ø 110

ART. 2020.AR

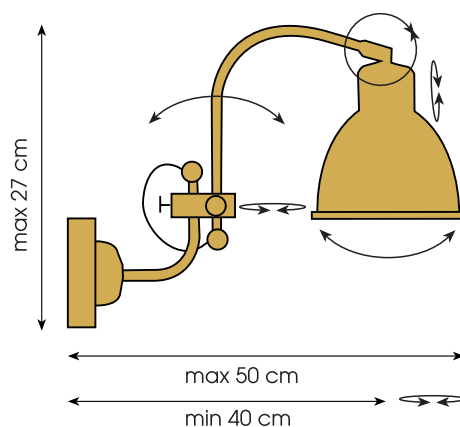

ORIENTABILE  
ORIENTABLE  
ADJUSTABLE  
EINSTERLLBAR

**.A.AR.BA.NA**= OTTONE ANTICIZZATO / AGED BRASS / LAITON VIEILLI / ANTIKISIERTER MESSING

**.AR**



ART. 2020.AR

**.NA**



ART. 2020.NA

**.BA**



ART. 2020.BA

**.A**



ART. 2020.A

Ø 11 cm

CE IP 20 - E 27

Max Watt 52

20/23 Watt

LED bulb  
lampadina a LED

CLASSE EFFICIENZA  
ENERGETICA A+ ÷ E  
energy efficiency classes



Lampadario 2 luci  
Ceiling lamp  
Aufhängung  
Suspension



ART. 1884.AR

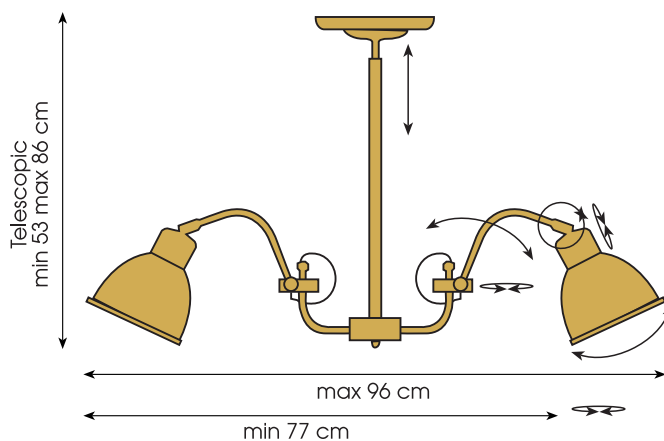

ORIENTABILE  
ORIENTABLE  
ADJUSTABLE  
EINSTERLLBAR

**.A.AR.BA.NA=** OTTONE ANTICIZZATO / AGED BRASS / LAITON VIEILLI / ANTIKISIERTER MESSING

**.AR**



ART. 1884.AR

**.NA**



ART. 1884.NA

**.BA**



ART. 1884.BA

**.A**



ART. 1884.A

CE IP 20 - E 27

Max Watt 52 x 2

20/23 Watt

LED bulb  
lampadina a LED

CLASSE EFFICIENZA ENERGETICA  
energy efficiency classes A+ ÷ E



Lampadario 3 luci  
Ceiling lamp  
Aufhängung  
Suspension



**.A.AR.BA.NA=** OTTONE ANTICIZZATO / AGED BRASS / LAITON VIEILLI / ANTIKISIERTER MESSING







Lampada da parete  
Wall lamp  
Wandlampe  
Applique



Ø 110

ART. 1880.NA

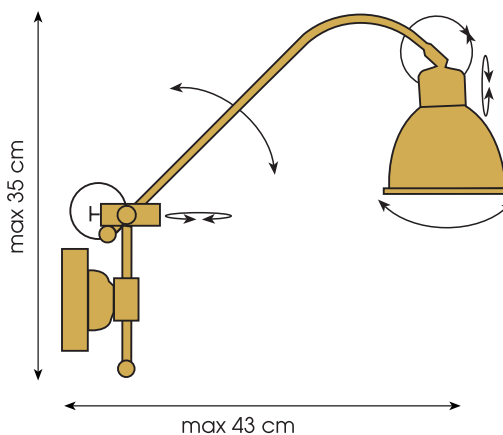

ORIENTABILE  
ORIENTABLE  
ADJUSTABLE  
EINSTELLBAR

**.A.AR.BA.NA= OTTONE ANTICHIZZATO / AGED BRASS / LAITON VIEILLI / ANTIKISIERTER MESSING**

**.AR**



ART. 1880.AR

**.NA**



ART. 1880.NA

**.BA**



ART. 1880.BA

**.A**



ART. 1880.A

Ø 11 cm

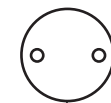

CE IP 20 - E 27

Max Watt 52

20/23 Watt

LED bulb  
lampadina a LED

CLASSE EFFICIENZA ENERGETICA  
energy efficiency classes A+ ÷ E



Lampada da parete  
Wall lamp  
Wandlampe  
Applique



ART. 1881.BA

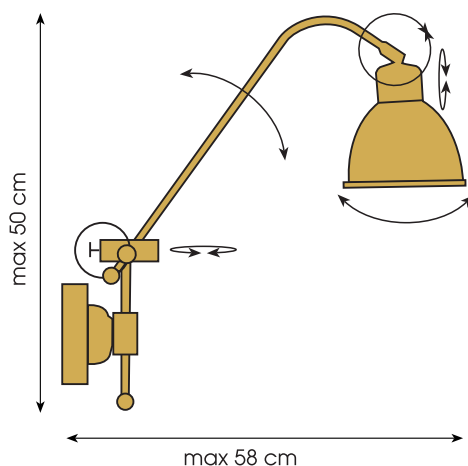

ORIENTABILE  
ORIENTABLE  
ADJUSTABLE  
EINSTERLLBAR

**.A.AR.BA.NA** = OTTONE ANTICHISSATO / AGED BRASS / LAITON VIEILLI / ANTIKISIERTER MESSING

**.AR**



ART. 1881.AR

**.NA**



ART. 1881.NA

**.BA**



ART. 1881.BA

**.A**



ART. 1881.A

Ø 11 cm



CE IP 20 - E 27

216

Max Watt 52

20/23 Watt

LED bulb  
lampadina a LED

CLASSE EFFICIENZA ENERGETICA  
energy efficiency classes A+ ÷ E



Lampada da parete  
Wall lamp  
Wandlampe  
Applique



ART. 1882.A

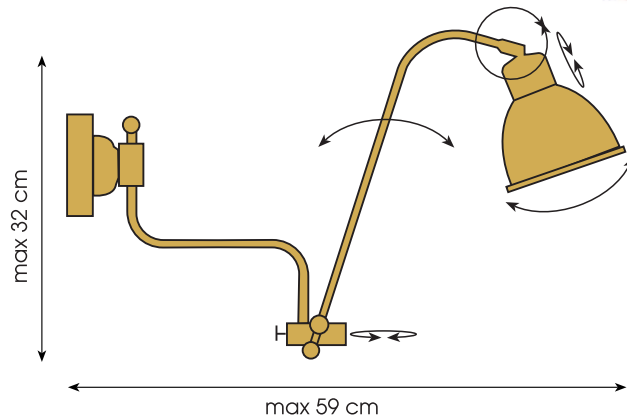

ORIENTABILE  
ORIENTABLE  
ADJUSTABLE  
EINSTERLLBAR

**.A.AR.BA.NA=** OTTONE ANTICHIZZATO / AGED BRASS / LAITON VIEILLI / ANTIKISIERTER MESSING

Ø 11 cm

**.AR**



ART. 1882.AR

**.NA**



ART. 1882.NA

**.BA**



ART. 1882.BA

**.A**



ART. 1882.A

CE IP 20 - E 27

Max Watt 52

20/23 Watt

LED bulb  
lampadina a LED

CLASSE EFFICIENZA ENERGETICA  
energy efficiency classes A+ ÷ E





Lampada da parete  
 Wall lamp  
 Wandlampe  
 Applique



ART. 1883.AR

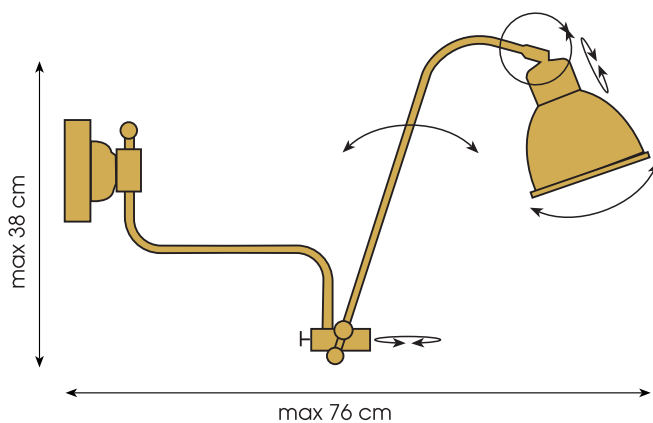

ORIENTABILE  
 ORIENTABLE  
 ADJUSTABLE  
 EINSTERLLBAR

**.A.AR.BA.NA= OTTONE ANTICHIZZATO / AGED BRASS / LAITON VIEILLI / ANTIKISIERTER MESSING**

Ø 11 cm

**.AR**



ART. 1883.AR

**.NA**



ART. 1883.NA

**.BA**



ART. 1883.BA

**.A**



ART. 1883.A



CE IP 20 - E 27

218

Max Watt 52

20/23 Watt

LED bulb  
 lampadina a LED

CLASSE EFFICIENZA ENERGETICA  
 energy efficiency classes A+ ÷ E



Lampada da tavolo  
Table lamp  
Tischlampe  
Lampe de table



ART. 1886.A

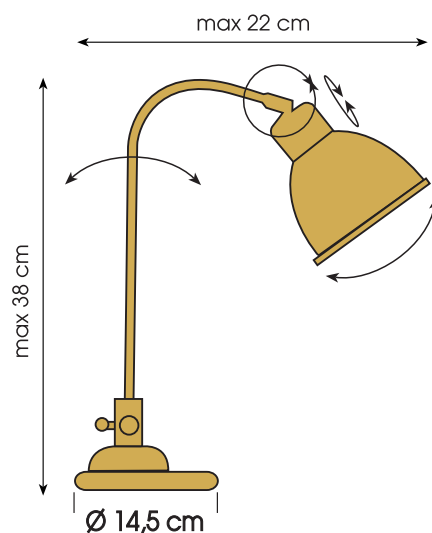

ORIENTABILE  
ORIENTABLE  
ADJUSTABLE  
EINSTERLLBAR

**.A.AR.BA.NA=** OTTONE ANTICHIZZATO / AGED BRASS / LAITON VIEILLI / ANTIKISIERTER MESSING

**.AR**



ART. 1886.AR

**.NA**



ART. 1886.NA

**.BA**



ART. 1886.BA

**.A**



ART. 1886.A

CE IP 20 - E 27

Max Watt 52

20/23 Watt

LED bulb  
lampadina a LED

CLASSE EFFICIENZA ENERGETICA  
energy efficiency classes A+ ÷ E



Lampada da tavolo  
Table lamp  
Tischlampe  
Lampe de table



ART. 1887.BA

ORIENTABILE  
ORIENTABLE  
ADJUSTABLE  
EINSTERLLBAR

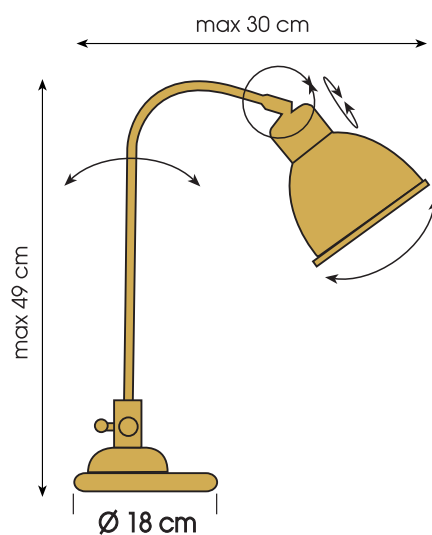

**.A.AR.BA.NA=** OTTONE ANTICHIZZATO / AGED BRASS / LAITON VIEILLI / ANTIKISIERTER MESSING

**.AR**



ART. 1887.AR

**.NA**



ART. 1887.NA

**.BA**



ART. 1887.BA

**.A**



ART. 1887.A

CE IP 20 - E 27  
220

Max Watt 52

20/23 Watt

LED bulb  
Lampadina a LED

CLASSE EFFICIENZA ENERGETICA  
energy efficiency classes A+ ÷ E





Lampada da tavolo  
Table lamp  
Tischlampe  
Lampe de table

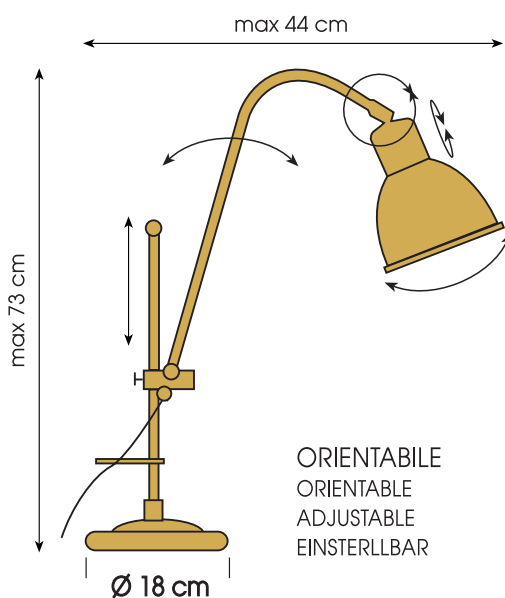

ART. 1888.NA

**.A.AR.BA.NA=** OTTONE ANTICHIZZATO / AGED BRASS / LAITON VIEILLI / ANTIKISIERTER MESSING

**.AR**



ART. 1888.AR

**.NA**



ART. 1888.NA

**.BA**



ART. 1888.BA

**.A**



ART. 1888.A

CE IP 20 - E 27

Max Watt 52

20/23 Watt

LED bulb  
Lampadina a LED

CLASSE EFFICIENZA ENERGETICA  
energy efficiency classes A+ ÷ E



Lampada a stelo  
 Floor lamp  
 Stehlamp  
 Lampadaire

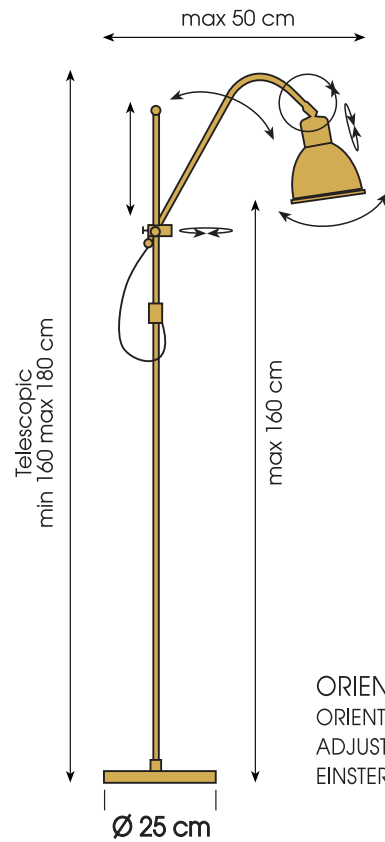

ORIENTABILE  
 ORIENTABLE  
 ADJUSTABLE  
 EINSTERLLBAR

**.A.AR.BA.NA= OTTONE ANTICHIZZATO / AGED BRASS / LAITON VIEILLI / ANTIKISIERTER MESSING**

**.AR**   **.NA**   **.BA**   **.A**



ART. 1889.AR   ART. 1889.NA   ART. 1889.BA   ART. 1889.A

ART. 1889.NA

CE IP 20 - E 27

Max Watt 52

20/23 Watt

LED bulb  
 lampadina a LED

CLASSE EFFICIENZA ENERGETICA  
 energy efficiency classes A+ ÷ E



Lampadario 2 luci  
Ceiling lamp  
Aufhängung  
Suspension



ART. 1885.BA

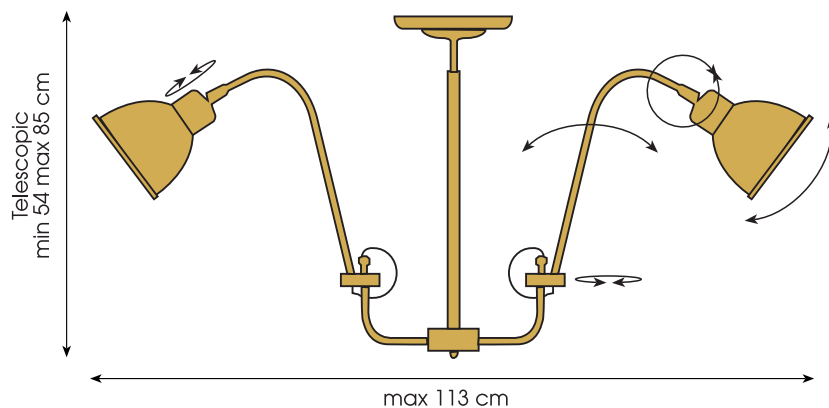

ORIENTABILE / ORIENTABLE / ADJUSTABLE / EINSTERLLBAR

**.A.AR.BA.NA= OTTONE ANTICIZZATO / AGED BRASS / LAITON VIEILLI / ANTIKISIERTER MESSING**

**.AR**



ART. 1885.AR

**.NA**



ART. 1885.NA

**.BA**



ART. 1885.BA

**.A**



ART. 1885.A

CE IP 20 - E 27

Max Watt 52 x 2

20/23 Watt

LED bulb  
lampadina a LED

CLASSE EFFICIENZA ENERGETICA  
energy efficiency classes A+ ÷ E





Lampadario 3 luci  
Ceiling lamp  
Aufhängung  
Suspension



ART. 2024.AR

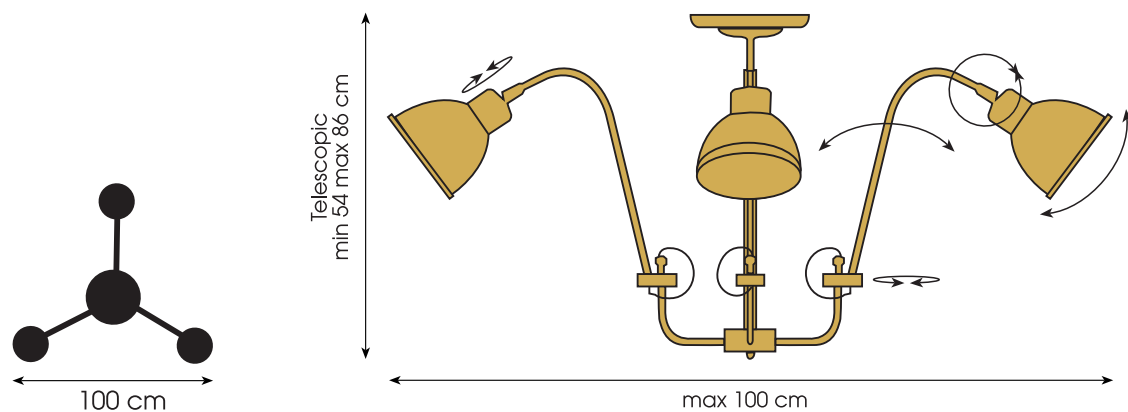

ORIENTABILE / ORIENTABLE / ADJUSTABLE / EINSTERLLBAR

**.A.AR.BA.NA= OTTONE ANTICHIZZATO / AGED BRASS / LAITON VIEILLI / ANTIKISIERTER MESSING**

**.AR**



ART. 2024.AR

**.NA**



ART. 2024.NA

**.BA**



ART. 2024.BA

**.A**



ART. 2024.A

CE IP 20 - E 27  
224

Max Watt 52 x 3

20/23 Watt

LED bulb  
lampadina a LED

CLASSE EFFICIENZA ENERGETICA  
energy efficiency classes A+ ÷ E



Art. RM1942

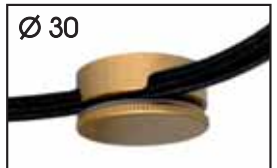

regolazione altezza incluso  
hight adjustement included

ART. 2024R.5LAR

Ø 200



Ø 310

Per 6 e più punti luce  
For 6 light and more

A RICHIESTA: cavo con lunghezza personalizzata e con più luci  
ON REQUEST: custom cable length or with more lights

2024R.3L - 2024R.4L - 2024R.5L - 2024R.6L - 2024R.7L - 2024R.8L - 2024R.9L - 2024R.10L

OTTONE ANTICHIZZATO  
AGED BRASS / LAITON VIEILLI / ANTIKISIERTER MESSING

Ø 11 cm



**.AR**



ART. 2030.AR.6



ART. 2030.AR.7



ART. 2030.AR.8

**.NA**



ART. 2030.NA.6



ART. 2030.NA.7



ART. 2030.NA.8

**.BA**



ART. 2030.BA.6



ART. 2030.BA.7



ART. 2030.BA.8

**.A**



ART. 2030.A.6



ART. 2030.A.7



ART. 2030.A.8

○ .6 = bianco/white

● .7 = ambra/amber

● .8 = verde/green

Colore vetri / Couleurs des opalines / Glass colors / Gläs farbe

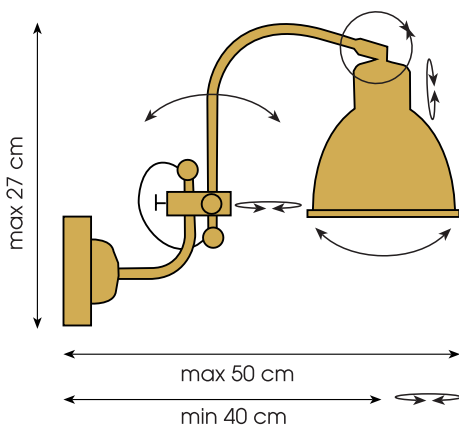

ORIENTABILE  
ORIENTABLE  
ADJUSTABLE  
EINSTERLLBAR

CE IP 20 - E 27

Light bulb icon Max Watt 52

U-shaped bulb icon 20/23 Watt

LED bulb icon LED bulb  
lampadina a LED

CLASSE EFFICIENZA  
ENERGETICA  
energy efficiency classes  
A+ ÷ E



Lampada da parete  
Wall lamp  
Wandlampe  
Applique



Ø 110

ART. 2030.AR.8



OTTONE ANTICHIZZATO  
AGED BRASS / LAITON VIEILLI / ANTIKISIERTER MESSING

**.AR**



ART. 2014.AR.6



ART. 2014.AR.7



ART. 2014.AR.8

**.NA**



ART. 2014.NA.6



ART. 2014.NA.7



ART. 2014.NA.8

**.BA**



ART. 2014.BA.6



ART. 2014.BA.7



ART. 2014.BA.8

**.A**



ART. 2014.A.6



ART. 2014.A.7



ART. 2014.A.8

○ .6 = bianco/white

● .7 = ambra/amber

● .8 = verde/green

Colore vetri / Couleurs des opallines / Glass colors / Gläs farbe

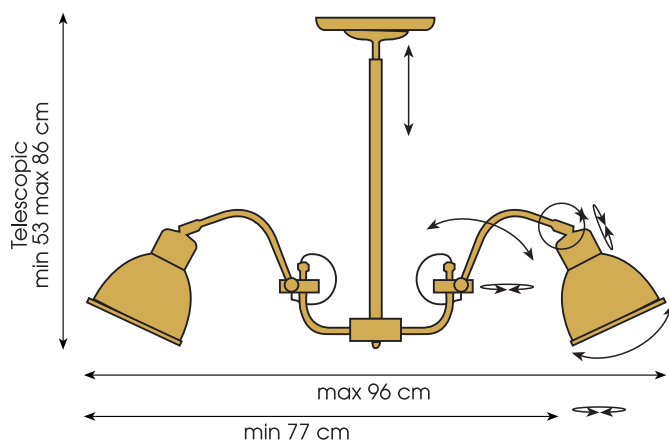

ORIENTABILE  
ORIENTABLE  
ADJUSTABLE  
EINSTERLLBAR

CE IP 20 - E 27

Max Watt 52 x 2

20/23 Watt

LED bulb  
lampadina a LED

CLASSE EFFICIENZA  
ENERGETICA  
energy efficiency classes  
A+ ÷ E

Lampadario 2 luci  
Ceiling lamp  
Aufhängung  
Suspension



ART. 2014.A.8





OTTONE ANTICIZZATO  
 AGED BRASS / LAITON VIEILLI / ANTIKISIERTER MESSING

**.AR**



ART. 2033.AR.6



ART. 2033.AR.7



ART. 2033.AR.8

**.NA**



ART. 2033.NA.6



ART. 2033.NA.7



ART. 2033.NA.8

**.BA**



ART. 2033.BA.6



ART. 2033.BA.7



ART. 2033.BA.8

**.A**



ART. 2033.A.6



ART. 2033.A.7



ART. 2033.A.8

○ .6 = bianco/white

● .7 = ambra/amber

● .8 = verde/green

Colore vetri / Couleurs des opalines / Glass colors / Gläs farbe

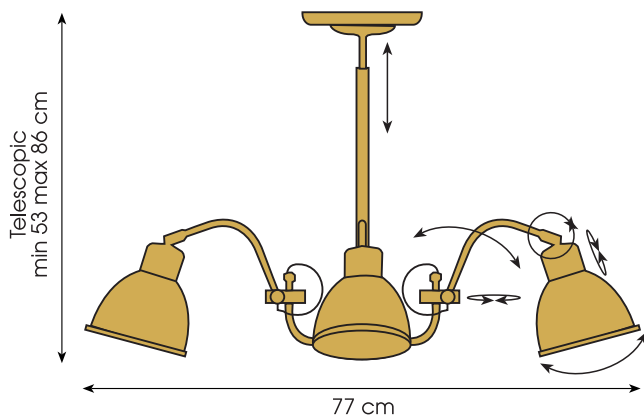

ORIENTABILE  
 ORIENTABLE  
 ADJUSTABLE  
 EINSTERLLBAR

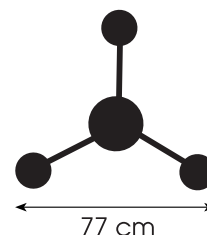

CE IP 20 - E 27

Max Watt 52 x 3

20/23 Watt

LED bulb  
 lampadina a LED

CLASSE EFFICIENZA  
 ENERGETICA  
 energy efficiency classes  
 A+ ÷ E

Lampadario 3 luci  
Ceiling lamp  
Aufhängung  
Suspension



OTTONE ANTICHIZZATO  
 AGED BRASS / LAITON VIEILLI / ANTIKISIERTER MESSING

Ø 11 cm

**.AR**



ART. 2010.AR.6



ART. 2010.AR.7



ART. 2010.AR.8

**.NA**



ART. 2010.NA.6



ART. 2010.NA.7



ART. 2010.NA.8

**.BA**



ART. 2010.BA.6



ART. 2010.BA.7



ART. 2010.BA.8

**.A**



ART. 2010.A.6



ART. 2010.A.7



ART. 2010.A.8

○ .6 = bianco/white

● .7 = ambra/amber

● .8 = verde/green

Colore vetri / Couleurs des opallines / Glass colors / Gläs farbe

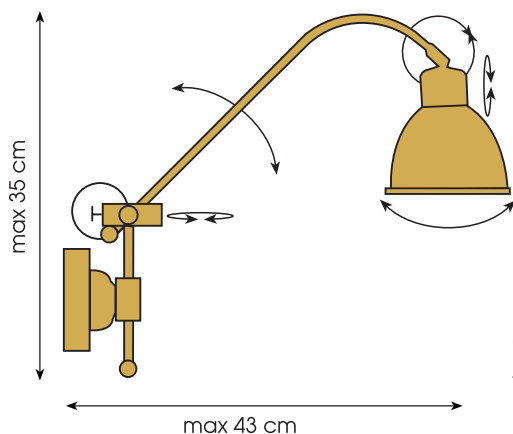

ORIENTABILE  
 ORIENTABLE  
 ADJUSTABLE  
 EINSTERLLBAR

CE IP 20 - E 27

Light bulb icon Max Watt 52

Light bulb icon 20/23 Watt

Light bulb icon LED bulb  
 lampadina a LED

CLASSE EFFICIENZA  
 ENERGETICA  
 energy efficiency classes  
**A+ ÷ E**



Lampada da parete  
Wall lamp  
Wandlampe  
Applique



ART. 2010.BA.7



OTTONE ANTICIZZATO  
AGED BRASS / LAITON VIEILLI / ANTIKISIERTER MESSING

Ø 11 cm

**.AR**



ART. 2011.AR.6



ART. 2011.AR.7



ART. 2011.AR.8

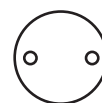

**.NA**



ART. 2011.NA.6



ART. 2011.NA.7



ART. 2011.NA.8

**.BA**



ART. 2011.BA.6



ART. 2011.BA.7



ART. 2011.BA.8

**.A**



ART. 2011.A.6



ART. 2011.A.7



ART. 2011.A.8

○ .6 = bianco/white

● .7 = ambra/amber

● .8 = verde/green

Colore vetri / Couleurs des opalines / Glass colors / Gläs farbe

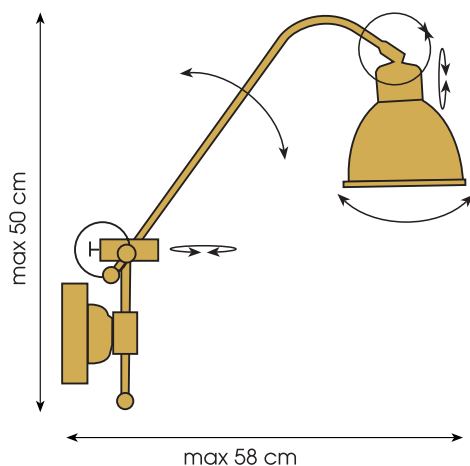

ORIENTABILE  
ORIENTABLE  
ADJUSTABLE  
EINSTERLLBAR

CE IP 20 - E 27

Max Watt 52

20/23 Watt

LED bulb  
lampadina a LED

CLASSE EFFICIENZA  
ENERGETICA  
energy efficiency classes  
A+ ÷ E

Lampada da parete  
Wall lamp  
Wandlampe  
Applique



ART. 2011.A.8





OTTONE ANTICHIZZATO  
AGED BRASS / LAITON VIEILLI / ANTIKISIERTER MESSING

Ø 11 cm

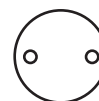

**.AR**



ART. 2012.AR.6



ART. 2012.AR.7



ART. 2012.AR.8

**.NA**



ART. 2012.NA.6



ART. 2012.NA.7



ART. 2012.NA.8

**.BA**



ART. 2012.BA.6



ART. 2012.BA.7



ART. 2012.BA.8

**.A**



ART. 2012.A.6



ART. 2012.A.7



ART. 2012.A.8

○ .6 = bianco/white

● .7 = ambra/amber

● .8 = verde/green

Colore vetri / Couleurs des opalines / Glass colors / Gläs farbe

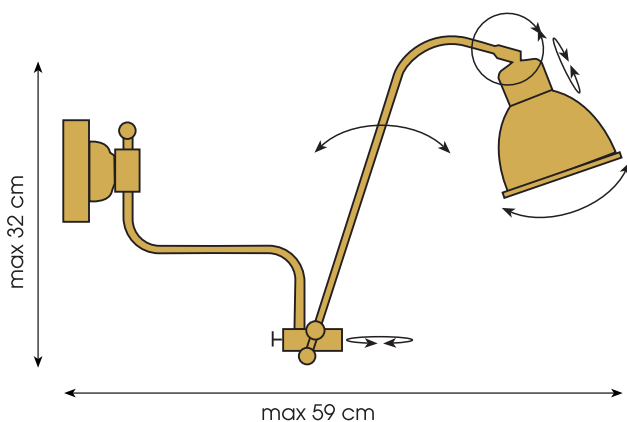

ORIENTABILE  
ORIENTABLE  
ADJUSTABLE  
EINSTERLLBAR

CE IP 20 - E 27

Max Watt 52

20/23 Watt

LED bulb  
lampadina a LED

CLASSE EFFICIENZA  
ENERGETICA  
energy efficiency classes  
A+ ÷ E

Lampada da parete

Wall lamp

Wandlampe

Applique



ART. 2012.NA.7



OTTONE ANTICHIZZATO  
 AGED BRASS / LAITON VIEILLI / ANTIKISIERTER MESSING

Ø 11 cm

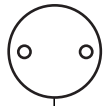

**.AR**



ART. 2013.AR.6



ART. 2013.AR.7



ART. 2013.AR.8

**.NA**



ART. 2013.NA.6



ART. 2013.NA.7



ART. 2013.NA.8

**.BA**



ART. 2013.BA.6



ART. 2013.BA.7



ART. 2013.BA.8

**.A**



ART. 2013.A.6



ART. 2013.A.7



ART. 2013.A.8

○ .6 = bianco/white

● .7 = ambra/amber

● .8 = verde/green

Colore vetri / Couleurs des opalines / Glass colors / Gläs farbe

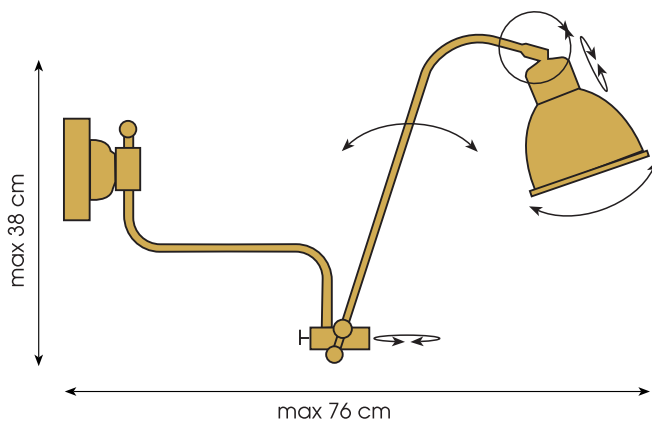

ORIENTABILE  
 ORIENTABLE  
 ADJUSTABLE  
 EINSTERLLBAR

CE IP 20 - E 27

Lightbulb icon Max Watt 52

U-shaped bulb icon 20/23 Watt

LED bulb icon LED bulb lampadina a LED

CLASSE EFFICIENZA  
 ENERGETICA  
 energy efficiency classes  
 A+ ÷ E



Lampada da parete

Wall lamp

Wandlampe

Applique



ART. 2013.AR.6



OTTONE ANTICIZZATO  
AGED BRASS / LAITON VIEILLI / ANTIKISIERTER MESSING

**.AR**



ART. 2016.AR.6



ART. 2016.AR.7



ART. 2016.AR.8

**.NA**



ART. 2016.NA.6



ART. 2016.NA.7



ART. 2016.NA.8

**.BA**



ART. 2016.BA.6



ART. 2016.BA.7



ART. 2016.BA.8

**.A**



ART. 2016.A.6



ART. 2016.A.7



ART. 2016.A.8

○ .6 = bianco/white

● .7 = ambra/amber

● .8 = verde/green

Colore vetri / Couleurs des opalines / Glass colors / Gläs farbe

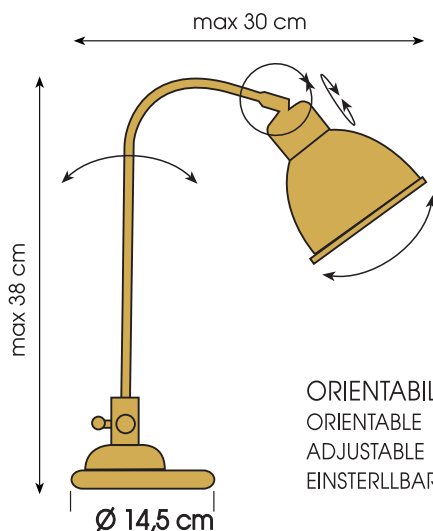

CE IP 20 - E 27

Max Watt 52

20/23 Watt

LED bulb  
lampadina a LED

CLASSE EFFICIENZA  
ENERGETICA  
energy efficiency classes  
A+ ÷ E

Lampada da tavolo

Table lamp

Tischlampe

Lampe de table



ART. 2016.NA.6





OTTONE ANTICHIZZATO  
AGED BRASS / LAITON VIEILLI / ANTIKISIERTER MESSING

**.AR**



ART. 2017.AR.6



ART. 2017.AR.7



ART. 2017.AR.8

**.NA**



ART. 2017.NA.6



ART. 2017.NA.7



ART. 2017.NA.8

**.BA**



ART. 2017.BA.6



ART. 2017.BA.7



ART. 2017.BA.8

**.A**



ART. 2017.A.6



ART. 2017.A.7



ART. 2017.A.8

○ .6 = bianco/white

● .7 = ambra/amber

● .8 = verde/green

Colore vetri / Couleurs des opalines / Glass colors / Gläs farbe

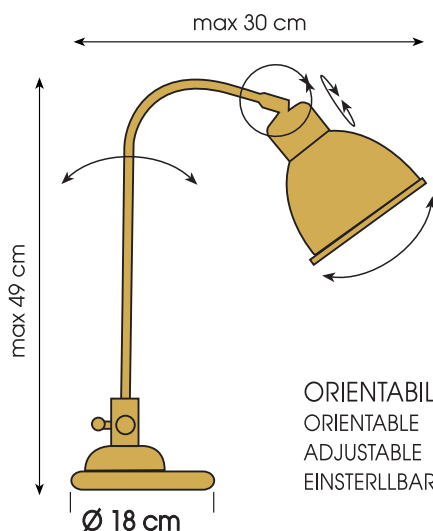

ORIENTABILE  
ORIENTABLE  
ADJUSTABLE  
EINSTELLBAR

CE IP 20 - E 27

Max Watt 52

20/23 Watt

LED bulb  
lampadina a LED

CLASSE EFFICIENZA  
ENERGETICA  
energy efficiency classes  
A+ ÷ E

Lampada da tavolo  
Table lamp  
Tischlampe  
Lampe de table



ART. 2017.A.8



OTTONE ANTICIZZATO  
AGED BRASS / LAITON VIEILLI / ANTIKISIERTER MESSING

**.AR**



ART. 2018.AR.6



ART. 2018.AR.7



ART. 2018.AR.8

**.NA**



ART. 2018.NA.6



ART. 2018.NA.7



ART. 2018.NA.8

**.BA**



ART. 2018.BA.6



ART. 2018.BA.7



ART. 2018.BA.8

**.A**



ART. 2018.A.6



ART. 2018.A.7



ART. 2018.A.8

○ .6 = bianco/white

● .7 = ambra/amber

● .8 = verde/green

Colore vetri / Couleurs des opalines / Glass colors / Gläs farbe

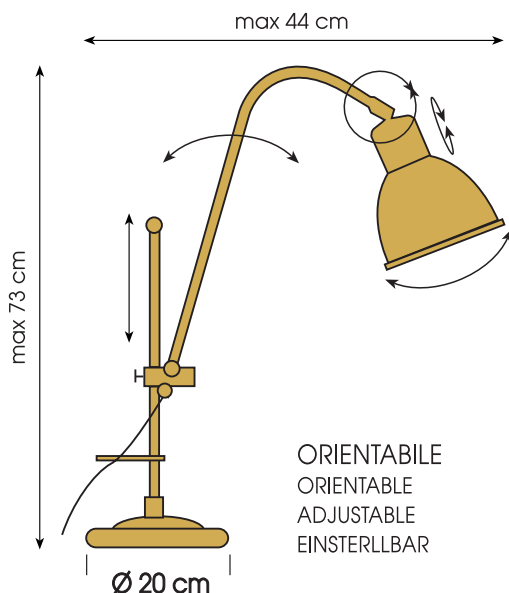

ORIENTABILE  
ORIENTABLE  
ADJUSTABLE  
EINSTERLLBAR

CE IP 20 - E 27

Max Watt 52

20/23 Watt

LED bulb  
lampadina a LED

CLASSE EFFICIENZA  
ENERGETICA  
energy efficiency classes  
A+ ÷ E



Lampada da tavolo  
Table lamp  
Tischlampe  
Lampe de table



ART. 2018.AR.7



OTTONE ANTICIZZATO  
AGED BRASS / LAITON VIEILLI / ANTIKISIERTER MESSING

**.AR**



ART. 2019.AR.6 ART. 2019.AR.7 ART. 2019.AR.8

**.NA**



ART. 2019.NA.6 ART. 2019.NA.7 ART. 2019.NA.8

**.BA**



ART. 2019.BA.6 ART. 2019.BA.7 ART. 2019.BA.8

**.A**



ART. 2019.A.6 ART. 2019.A.7 ART. 2019.A.8

○ .6 = bianco/white ● .7 = ambra/amber ● .8 = verde/green

○ .6 = bianco/white ● .7 = ambra/amber ● .8 = verde/green

Colore vetri / Couleurs des opalines / Glass colors / Gläs farbe

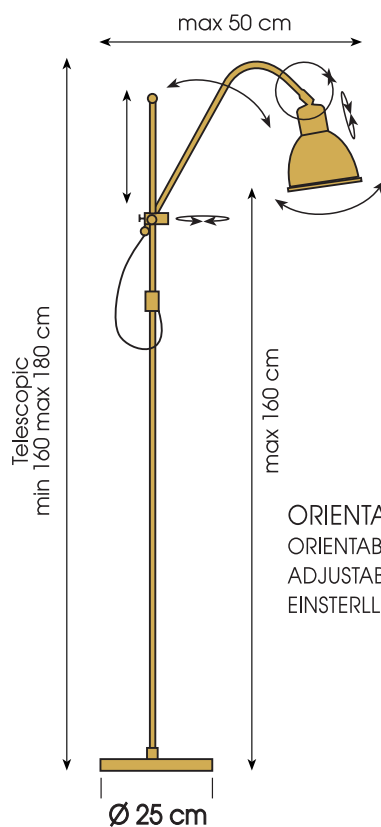

ORIENTABILE  
ORIENTABLE  
ADJUSTABLE  
EINSTERLLBAR

CE IP 20 - E 27 Max Watt 52

CLASSE EFFICIENZA ENERGETICA  
energy efficiency classes A+ ÷ E

20/23 Watt LED bulb  
lampadina a LED

Piantana  
Floor lamp  
Stehlamp  
Lampadaire



ART. 2019.BA.8



OTTONE ANTICIZZATO  
AGED BRASS / LAITON VIEILLI / ANTIKISIERTER MESSING

**.AR**



ART. 2015.AR.6



ART. 2015.AR.7



ART. 2015.AR.8

**.NA**



ART. 2015.NA.6



ART. 2015.NA.7



ART. 2015.NA.8

**.BA**



ART. 2015.BA.6



ART. 2015.BA.7



ART. 2015.BA.8

**.A**



ART. 2015.A.6



ART. 2015.A.7



ART. 2015.A.8

○ .6 = bianco/white

● .7 = ambra/amber

● .8 = verde/green

Colore vetri / Couleurs des opalines / Glass colors / Gläs farbe

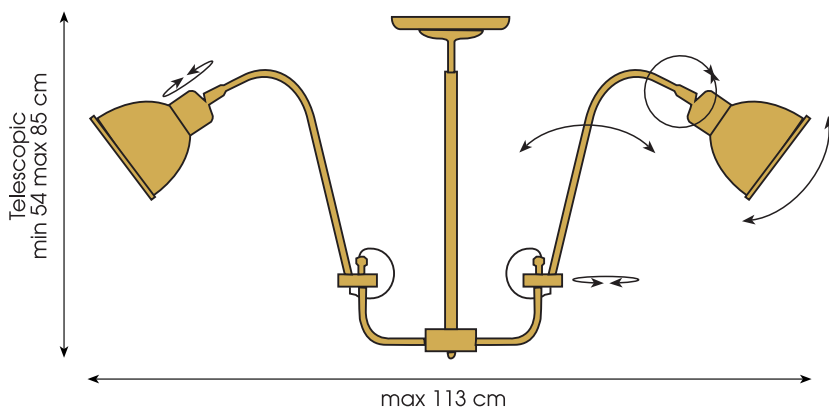

ORIENTABILE  
ORIENTABLE  
ADJUSTABLE  
EINSTERLLBAR

CE IP 20 - E 27

Max Watt 52 x 2

20/23 Watt

LED bulb  
lampadina a LED

CLASSE EFFICIENZA  
ENERGETICA  
energy efficiency classes  
A+ ÷ E

Lampadario 5 luci  
Ceiling lamp  
Aufhängung  
Suspension

**New**



ART. 2034.5L.AR.6



Lampadario 5 luci  
 Ceiling lamp  
 Aufhängung  
 Suspension



ART. 2034.5L.AR.8



Per 6 e più punti luce  
 For 6 light and more

A RICHIESTA: cavo con lunghezza personalizzata e con più luci  
 ON REQUEST: custom cable length or with more lights

2034.3L - 2034.4L - 2034.6L - 2034.7L - 2034.8L - 2034.9L - 2034.10L

○ .6 = bianco/white

● .7 = ambra/amber

● .8 = verde/green

Colore vetri / Couleurs des opalines / Glass colors / Gläs farbe

CE IP 20 - E 27

💡 Max Watt 52 x 3

💡 20/23 Watt

💡 LED bulb  
 lampadina a LED

CLASSE EFFICIENZA  
 ENERGETICA  
 energy efficiency classes  
 A+ ÷ E



Lampadario 5 luci  
Ceiling lamp  
Aufhängung  
Suspension

Art. RM1942

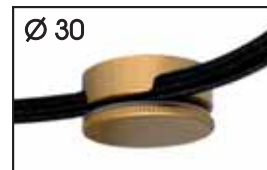

regolazione altezza incluso  
hight adjustment included



ART. 2034.5LAR.7



Ø 110



①



②



③



④



⑤



⑥

①  
**ART. 4030.AR**  
 H. 300 - Larg. 225  
 Ø 200

②  
**ART. 4031.AR**  
 H. 335 - Larg. 280  
 Ø 250

③  
**ART. 4032.AR**  
 H. 310 - Larg. 310  
 Ø 250

④  
**ART. 4033.AR**  
 H. 950 - Ø 200

⑤  
**ART. 4034.AR**  
 H. 1000 - Ø 250

⑥  
**ART. 4035.AR**  
 Ø 250

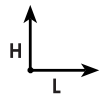

**.AR**

Colori ottone: superficie esterna del cappello  
 Brass colors: outer surface of the hat

**.AR**



**.BA**



**.AR.BA= OTTONE ANTICIZZATO**  
 AGED BRASS / LAITON VIEILLI / ANTIKISIERTER MESSING  
**non teme la salsedine / no problem with salt corrosion**

**CE** IP 20 - E 27  
 INDOOR LIGHTING

Max Watt 52



LED bulb  
 Lampadina a LED

lampadina non inclusa / bulbs not included

**CLASSE EFFICIENZA  
 ENERGETICA A+ ÷ E**  
 energy efficiency classes







OTTONE ANTICIZZATO  
AGED BRASS / LAITON VIEILLI / ANTIKISIERTER MESSING

Art. RM1942

Ø 30

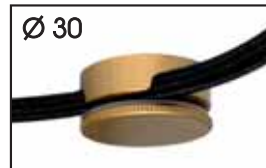

regolazione altezza incluso  
height adjustment included

**New**

ART. 4036.3LAR



ART. 4036.4LAR



Ø 310



Per 6 e più punti luce  
For 6 light and more

A RICHIESTA: cavo con lunghezza personalizzata e con più luci  
ON REQUEST: custom cable length or with more lights

4036.2LAR - 4036.4LAR - 4036.6LAR - 4036.7LAR - 4036.8LAR - 4036.9LAR - 4036.10LAR

OTTONE ANTICIZZATO  
AGED BRASS / LAITON VIEILLI / ANTIKISIERTER MESSING



regolazione altezza  
height adjustment



**ART. 4036.5LAR**

cavo / cable mm 1500 - Max Watt 5 x 46

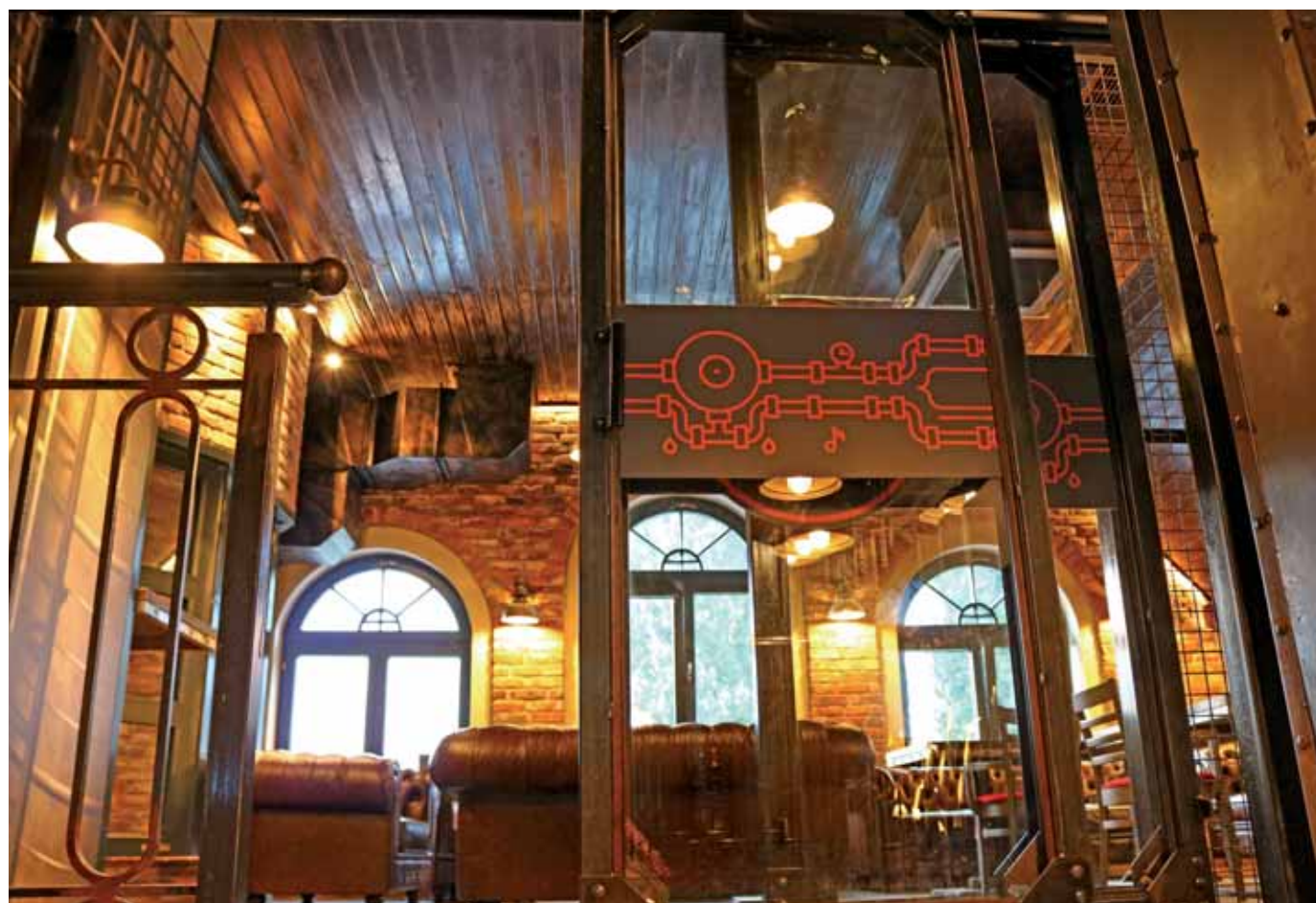













①  
ART. 1598.AR  
H. 400 - Larg. 250

②  
ART. 1600.V  
H. 970 - Larg. 200

③  
ART. 1604.AR  
H. 970 - Larg. 100

④  
ART. 1602.AR  
H. 810 - Larg. 370

Finitura ottone  
*Finition laiton*  
Brass finishes  
.A.AR.BA.V

Colore vetri  
*Couleurs verres*  
Glass colors  
Gläs farbe  
TRASPARENT

Cavo tessuto  
*Cable tissu*  
*Câble tissu*  
Kabel stuff

**CLASSE EFFICIENZA  
ENERGETICA**  
energy efficiency classes  
**A+ ÷ E**

CE IP 20 - E 27

Light bulb icon Max Watt 52

mm 63

Light bulb icon mm 160

20/23 Watt



LED bulb  
lampadina a LED

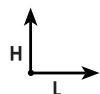



Ø 310



⑤  
ART. 1603.AR  
H. 1060 - Larg. 370

⑥  
ART. 1601.AR  
H. 1200 - Larg. 400

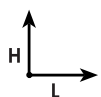

Vetro trasparente bulicoso - Bubble air transparent glass





Ø 100



Ø 110

Ø 260



①  
ART. 1639.AR  
H. 320 - Larg. 180

②  
ART. 1640.V  
H. 970 - Larg. 165

③  
ART. 1643.AR  
H. 970 - Larg. 165

④  
ART. 1644.AR  
H. 760 - Larg. 350

Finitura ottone  
Finition laiton  
Brass finishes  
.A.AR.BA.V

Colore vetri  
Couleurs verres  
Glass colors  
Gläs farbe  
TRASPARENT

Cavo tessuto  
Cable tissu  
Câble tissu  
Kabel stoff

**CLASSE EFFICIENZA  
ENERGETICA**  
energy efficiency classes  
**A+ ÷ E**

CE IP 20 - E 27

Max Watt 52x1

mm 63



20/23 Watt



LED bulb  
lampadina a LED



Ø 310

Lampadario 5 luci  
Ceiling lamp  
Aufhängung  
Suspension

Art. RM1942



regolazione altezza incluso  
hight adjustement included



⑤

**New**

ART. 1643.5LAR



Ø 310

Per 6 e più punti luce  
For 6 light and more

A RICHIESTA: cavo con lunghezza personalizzata e con più luci  
ON REQUEST: custom cable length or with more lights

1643.3L - 1643.4L - 1643.6L - 1643.7L - 1643.8L - 1643.9L - 1643.10L

⑤

ART. 1645.AR  
H. 960 - Larg. 350



Finitura ottone  
Finition laiton  
Brass finishes  
.A.AR.BA.V

Colore vetri  
Couleurs verres  
Glass colors  
Gläs farbe  
TRASPARENTE

Cavo tessuto  
Cable tissu  
Câble tissu  
Kabel stuff

CLASSE EFFICIENZA  
ENERGETICA  
energy efficiency classes  
A+ ÷ E

CE IP 20 - E 27

Max Watt 52x1

mm 63



20/23 Watt



LED bulb  
lampadina a LED

ART. 2034.5LAR.7



Vetro trasparente bulicoso - Bubble air transparent glass



①  
ART. 1641.AR  
H. 320 - Larg. 180

②  
ART. 1642.AR  
H. 970 - Larg. 165

③  
ART. 1646.AR  
H. 970 - Larg. 165

④  
ART. 1647.AR  
H. 760 - Larg. 350

Finitura ottone  
*Finition laiton*  
Brass finishes  
.A.AR.BA.V

Colore vetri  
*Couleurs verres*  
Glass colors  
Gläs farbe  
TRASPARENT

Cavo tessuto  
*Cable tissu*  
*Câble tissu*  
Kabel stuff

CLASSE EFFICIENZA  
ENERGETICA  
energy efficiency classes  
A+ ÷ E

CE IP 20 - E 27

Max Watt 52x1

mm 63  
mm 160



20/23 Watt  
LED bulb  
lampadina a LED





Ø 310



⑤

Lampadario 5 luci  
Ceiling lamp  
Aufhängung  
Suspension

Art. RM1942



regolazione altezza incluso  
height adjustment included

**New**

ART. 1646.5L.AR



Ø 310

Per 6 e più punti luce  
For 6 light and more

A RICHIESTA: cavo con lunghezza personalizzata e con più luci  
ON REQUEST: custom cable length or with more lights

1646.3L - 1646.4L - 1646.6L - 1646.7L - 1648.8L - 1649.9L - 1649.10L

⑤

ART. 1648.AR  
H. 960 - Larg. 350



Finitura ottone  
Finition laiton  
Brass finishes  
.A.AR.BA.V

Colore vetri  
Couleurs verres  
Glass colors  
Glás farbe  
TRASPARENT

Cavo tessuto  
Cable tissu  
Câble tissu  
Kabel stoff

CLASSE EFFICIENZA  
ENERGETICA  
energy efficiency classes  
A+ ÷ E

CE IP 20 - E 27  
Max Watt 52x1



20/23 Watt



LED bulb  
lampadina a LED



Vetro trasparente bulicoso - Bubble air transparent glass

# Serie Vanua

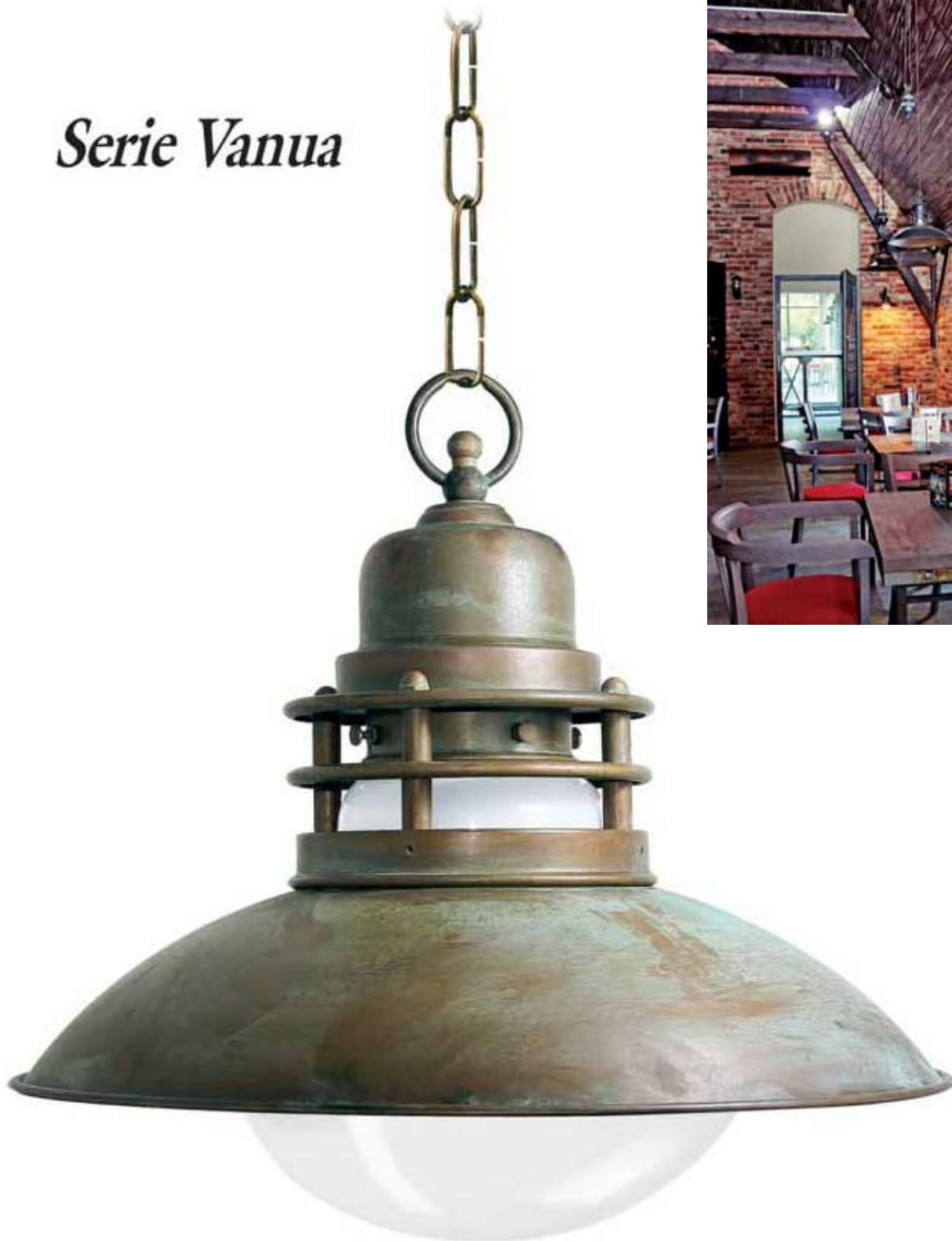

ART. 1005.AR  
H. 400 - Larg. 420

CE IP 20 - E 27

Max Watt 52

20/23 Watt

LED bulb  
lampadina a LED

CLASSE EFFICIENZA  
ENERGETICA  
energy efficiency classes  
A+ ÷ E

Finitura ottone  
Finition laiton  
Brass finishes

**.A.AR.BA**

Colore vetri / Couleurs verres / Glass colors / Gläs farbe  
.O = opale - .T = trasparente



ART. 1615.AR  
H. 420 - Prof. 240  
Paterre Ø 105



ART. 1616.AR  
H. 360 - Larg. 210



## Serie Guadalupa

CE IP 20 - E 27

Max Watt 52

20/23 Watt

LED bulb  
lampadina a LED

CLASSE EFFICIENZA  
ENERGETICA  
energy efficiency classes  
A+ ÷ E

Finitura ottone  
Finition laiton  
Brass finishes  
**.A.AR.BA**

Colore vetri / Couleurs verres / Glass colors / Gläs farbe  
trasparente / transparent



# Guadalupa

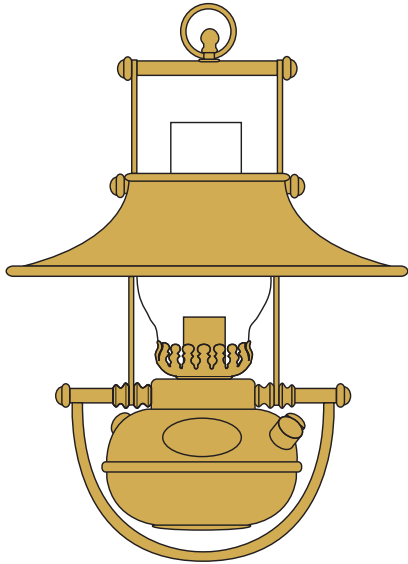

ART. 1606  
H. 540 - Larg. 400

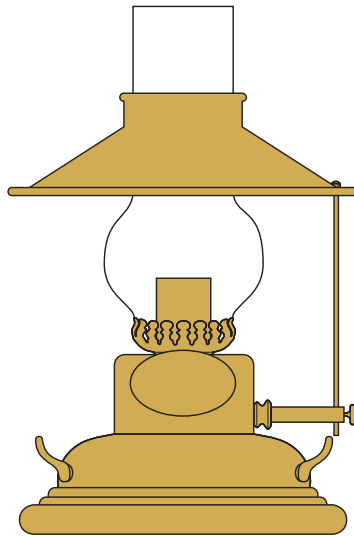

ART. 1616  
H. 360 - Larg. 210

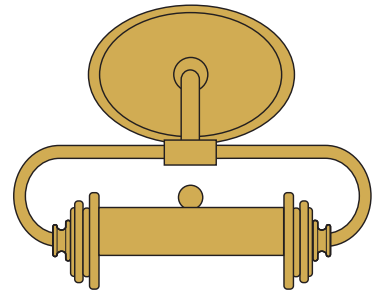

ART. 1625  
H. 260 - Larg. 330 - Prof. 150  
Max 28 Watt

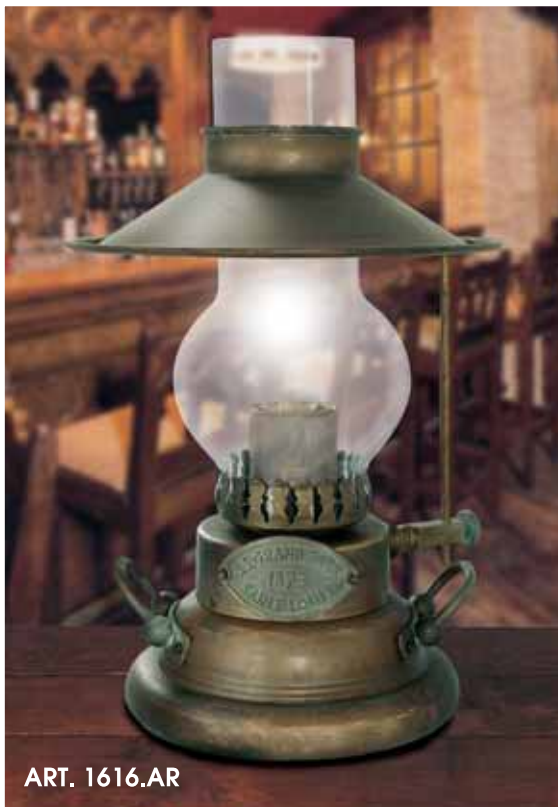

ART. 1616.AR



ART. 1625.AR

CE IP 20 - E 27

Max Watt 52

20/23 Watt

LED bulb  
lampadina a LED

**CLASSE EFFICIENZA  
ENERGETICA**  
energy efficiency classes  
**A++ E**

Finitura ottone  
Finition laiton  
Brass finishes

**.A.AR.BA**

Colore vetri / Couleurs verres / Glass colors / Gläs farbe  
trasparente / transparent



*Guadalupa*

ART. 1606.AR

# Country



Art. 1008.AR.7

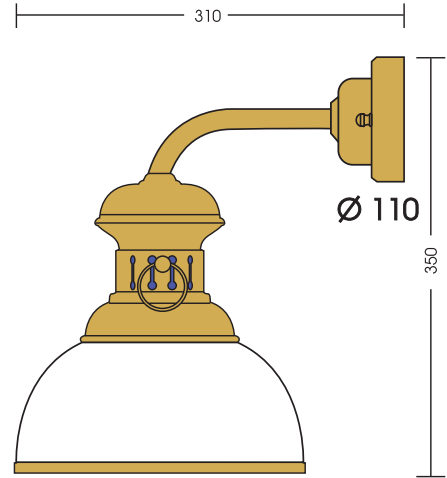

ART. 1008  
Vetro Ø 250 - Larg. 250

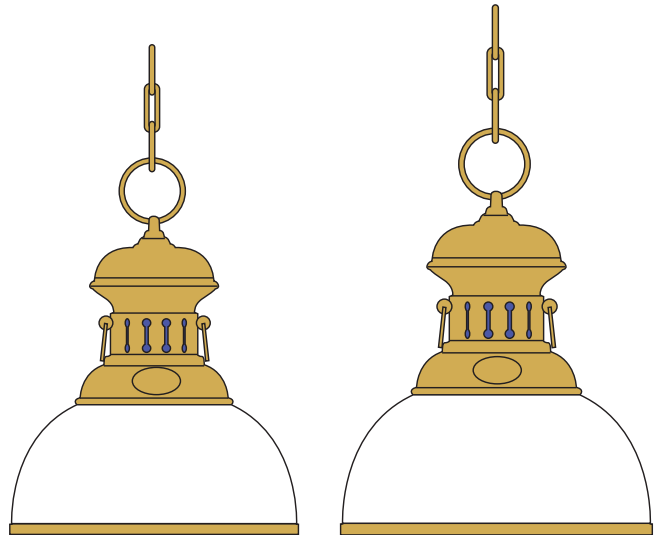

ART. 1010  
Vetro Ø 250 - H. 370

ART. 1011  
Vetro Ø 300 - H. 400

CE IP 20 - E 27

Max Watt 52

20/23 Watt

LED bulb  
lampadina a LED

CLASSE EFFICIENZA  
ENERGETICA  
energy efficiency classes  
A+ ÷ E

Finitura ottone  
Finition laiton  
Brass finishes

**.A.V.AR.BA**

Colore vetri / Couleurs verres / Glass colors / Gläs farbe

○ .6 = bianco/white    ● .7 = ambra/amber    ● .8 = verde/green



Art. 1011.A.6



*Country*



Art. 1011.V.6

# Solaris

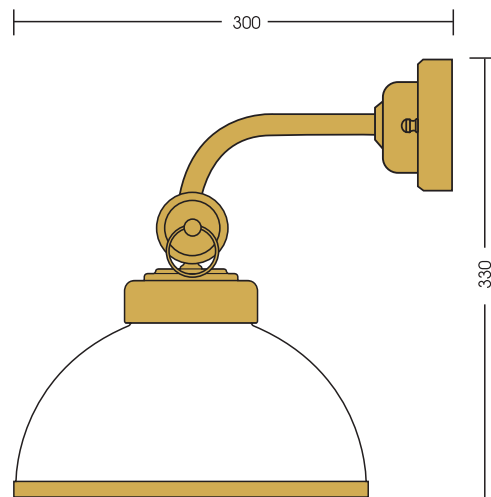

ART. 1018  
Vetro Ø 250 - Larg. 250

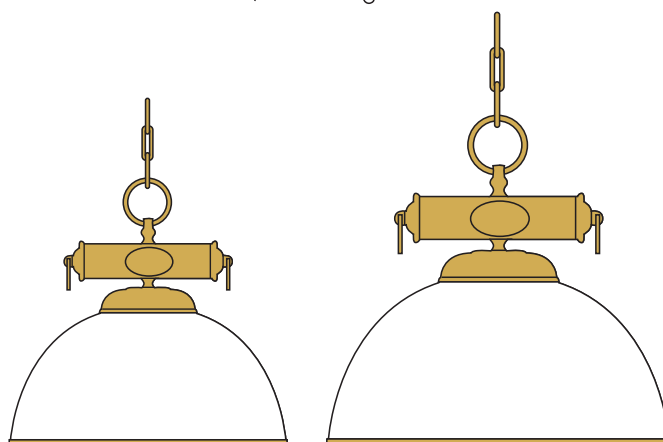

ART. 1020  
Vetro Ø 250 - H. 310

ART. 1021  
Vetro Ø 300 - H. 340

CE IP 20 - E 27

Max Watt 52

20/23 Watt

LED bulb  
lampadina a LED

CLASSE EFFICIENZA  
ENERGETICA  
energy efficiency classes  
A+ ÷ E

Finitura ottone  
Finition laiton  
Brass finishes

**.A.V.AR.BA**

Colore vetri / Couleurs verres / Glass colors / Gläs farbe

○ .6 = bianco/white    ● .7 = ambra/amber    ● .8 = verde/green

Art. 1023.V.6



*Solaris*



# Bahia

ART. 1006.AR

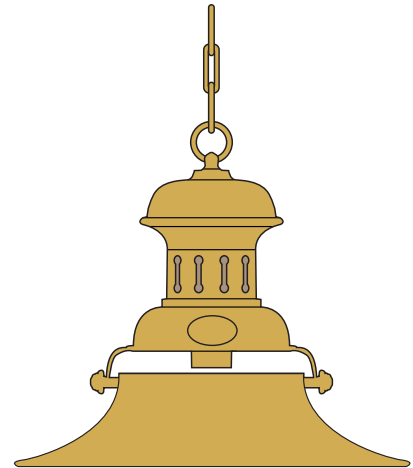

ART. 1006  
Ø 40 - H. 35

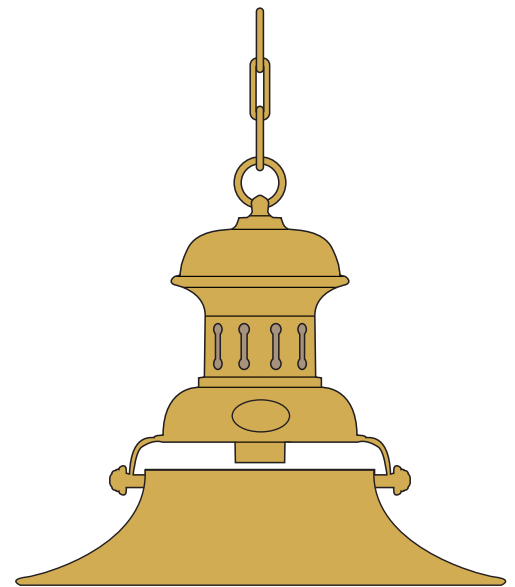

ART. 1007  
Ø 50 - H. 41

CE IP 20 - E 27

Max Watt 52

20/23 Watt

LED bulb  
lampadina a LED

CLASSE EFFICIENZA  
ENERGETICA  
energy efficiency classes  
A+ ÷ E

Finitura ottone  
Finition laiton  
Brass finishes

**.A.V.AR.BA**



*Bahia*

# Mariner

---

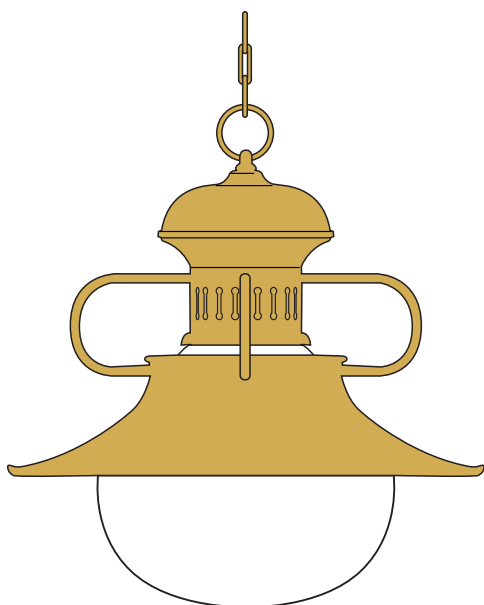

ART. 1050  
Ø 400 - H.450

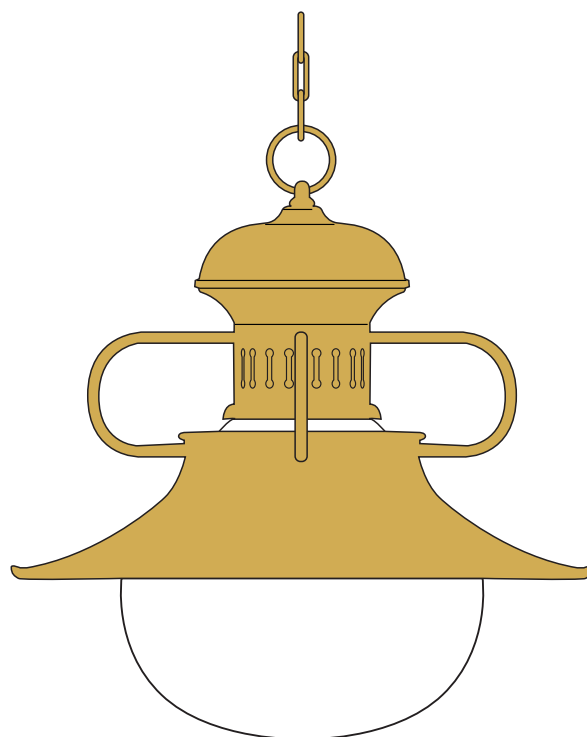

ART. 1051  
Ø 550 - H.500

---

CE IP 20 - E 27

Max Watt 52

20/23 Watt

LED bulb  
lampadina a LED

CLASSE EFFICIENZA  
ENERGETICA  
energy efficiency classes  
A+ ÷ E

Finitura ottone  
Finition laiton  
Brass finishes

**.A.V.AR.BA**

Colore vetri / Couleurs verres / Glass colors / Gläs farbe  
**trasparent**



ART. 1050.A



*Mariner*



ART. 1051.V



Vetro trasparente bulicoso - Bubble air transparent glass



Ø 110

**ART. 1240.AR**  
H. 380 - Larg. Ø 300 - Prof. 330



**ART. 1242.AR**  
H. 1000 - Larg. Ø 300



Ø 100

**ART. 1243.AR**  
H. 1100 - Larg. Ø 400



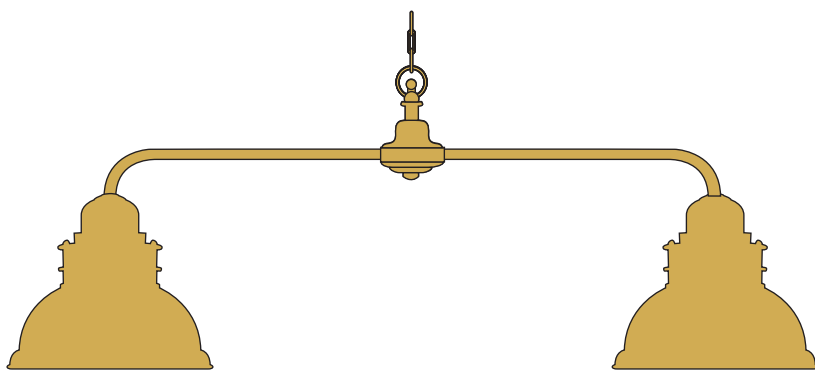

**ART. 1244.AR**  
H. 1243 - Larg. 860

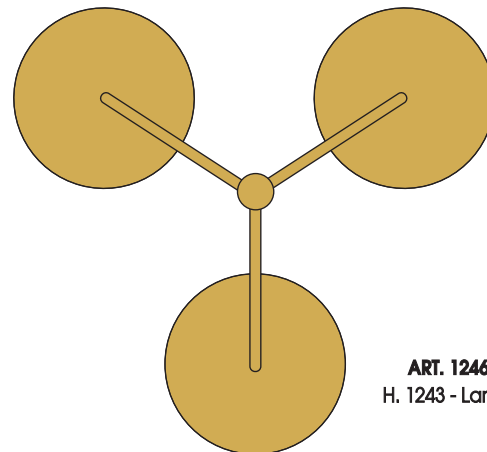

**ART. 1246.AR**  
H. 1243 - Larg. 860

Colori ottone/Couleurs laiton/Brass colors/Messing farbe

**.AR**



**.BA**



**.AR.BA.NA**= OTTONE ANTICHIZZATO / AGED BRASS / LAITON VIEILLI / ANTIKISIERTER MESSING

**CE** IP 20 - E 27  
INDOOR LIGHTING

 Max Watt 52

   
LED bulb  
lampadina a LED  
lampadina non inclusa / bulbs not included

**CLASSE EFFICIENZA ENERGETICA** A+ ÷ E  
energy efficiency classes



# Nautilus



Art. 1058.AR

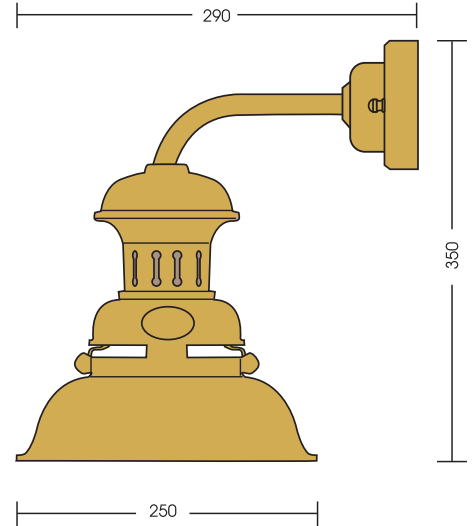

ART. 1058

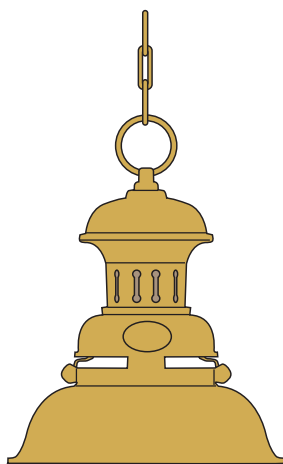

ART. 1060  
Ø 250 - H. 310

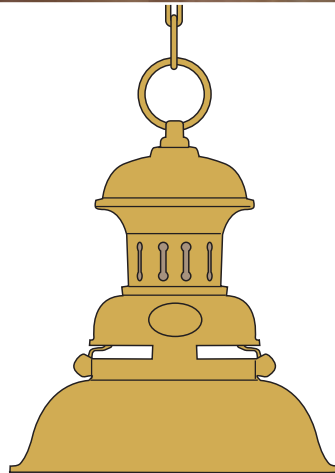

ART. 1061  
Ø 300 - H. 370

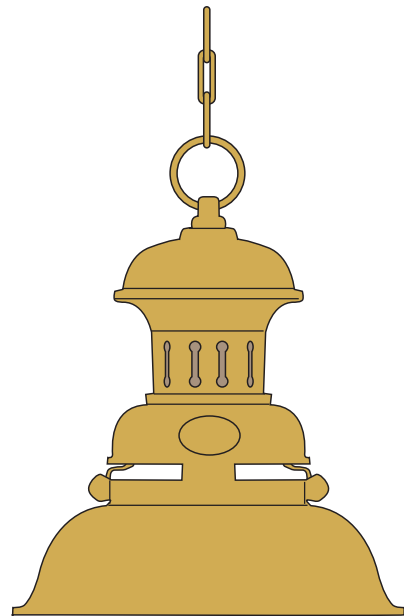

ART. 1062  
Ø 400 - H. 440

CE IP 20 - E 27

Max Watt 52

20/23 Watt

LED bulb  
lampadina a LED

CLASSE EFFICIENZA  
ENERGETICA  
energy efficiency classes  
A+ ÷ E

Finitura ottone  
Finition laiton  
Brass finishes

**.A.V.A.R.B.A**



*Nautilus*



# Galleon



Art. 1098.AR

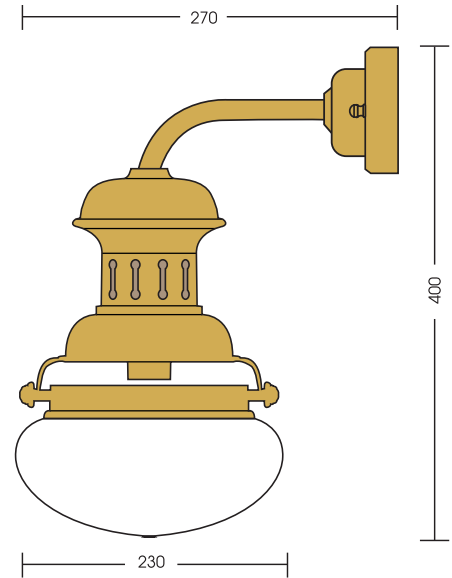

ART. 1098



ART. 1100  
Vetro Ø 250 - H.330

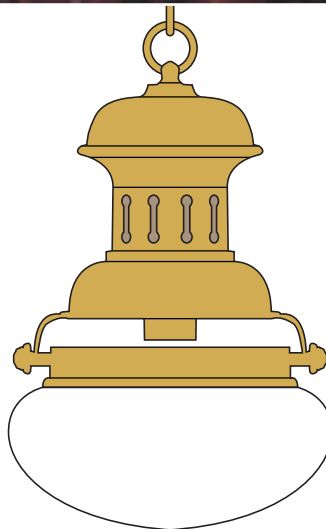

ART. 1101  
Vetro Ø 300 - H.400

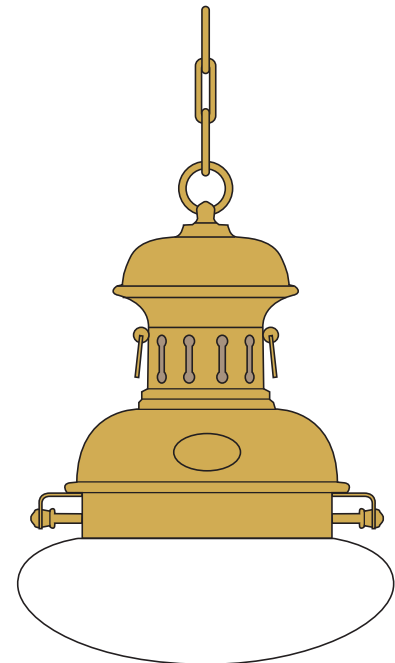

ART. 1112  
Vetro Ø 430 - H.530  
Max Watt 2 x 60

CE IP 20 - E 27

Max Watt 52

20/23 Watt

LED bulb  
lampadina a LED

CLASSE EFFICIENZA  
ENERGETICA  
energy efficiency classes  
A+ ÷ E

Finitura ottone  
Finition laiton  
Brass finishes

**.A.V.AR.BA**

Colore vetri / Couleurs verres / Glass colors / Gläs farbe  
**trasparent**



*Galleon*

Art. 1112.V



Art. 1112.AR



Vetro trasparente bulicoso - Bubble air transparent glass

# Martinica

---

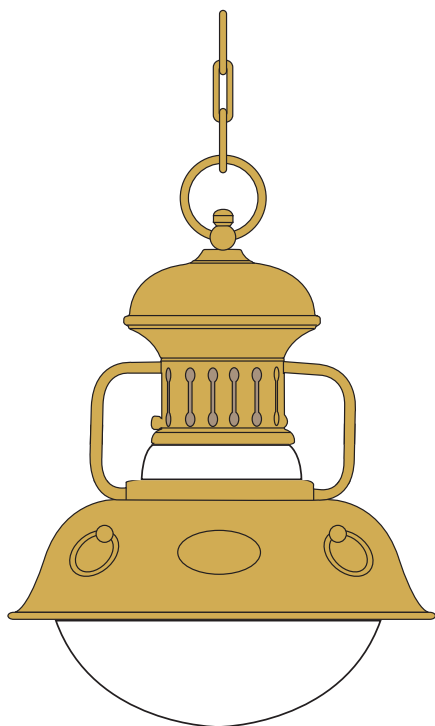

ART. 1607  
H. 400 - Larg. 320

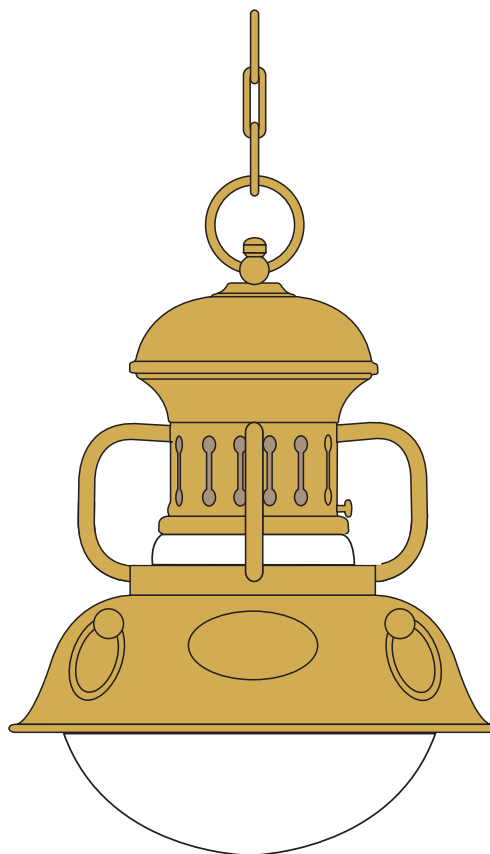

ART. 1608  
H. 530 - Larg. 410

---

CE IP 20 - E 27

Max Watt 52

20/23 Watt



LED bulb  
lampadina a LED

**CLASSE EFFICIENZA  
ENERGETICA**  
energy efficiency classes  
**A+ ÷ E**

Finitura ottone  
Finition laiton  
Brass finishes

**.A.V.AR.BA**

Colore vetri / Couleurs verres / Glass colors / Gläs farbe  
**trasparent**

# *Martinica*



Vetro trasparente bulicoso - Bubble air transparent glass



# Belleville

OTTONE

LAITON

BRASS

MESSING

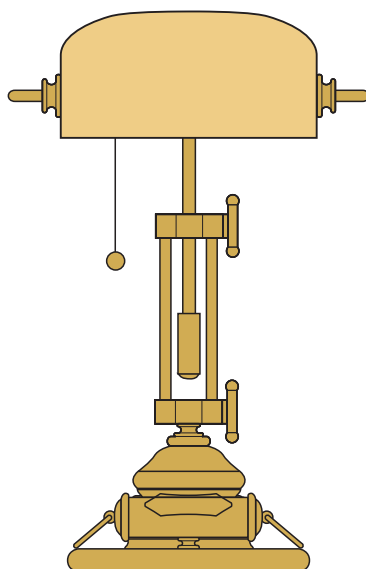

ART. 1506  
H. 730 - Larg. 330

OTTONE  
CON LEGNO

LAITON AVEC BOIS

BRASS WITH WOOD

MESSING MIT HOLZ

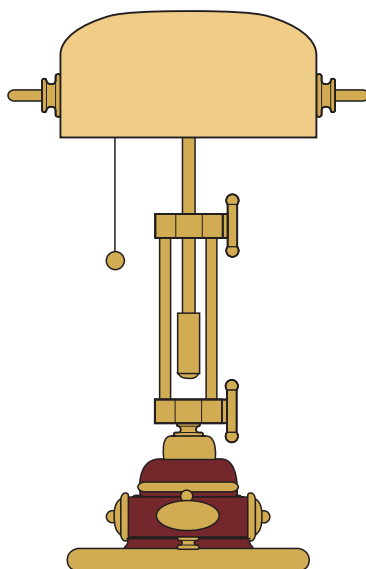

ART. 1507  
H. 730 - Larg. 330

CE IP 20 - E 27

Max Watt 52

20/23 Watt



LED bulb  
lampadina a LED

CLASSE EFFICIENZA  
ENERGETICA  
energy efficiency classes  
A+ ÷ E

Finitura ottone  
Finition laiton  
Brass finishes

**.A.V.AR.BA.D**

Colore vetri / Couleurs verres / Glass colors / Gläs farbe

○ .6 = bianco/white    ● .7 = ambra/amber    ● .8 = verde/green



ART. 1506.A.8



ART. 1507.A.6

*Belleville*

# Samoa

OTTONE

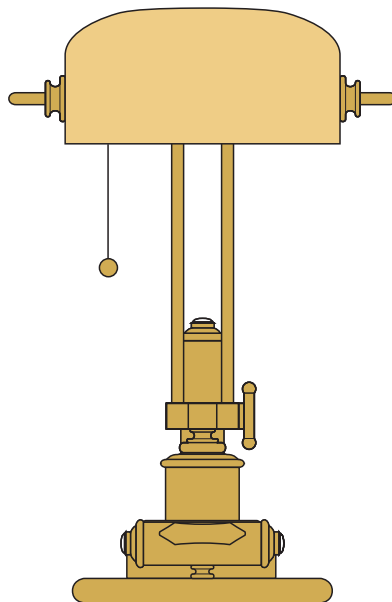

ART. 1512  
H. 570 - Larg. 310

OTTONE  
CON LEGNO

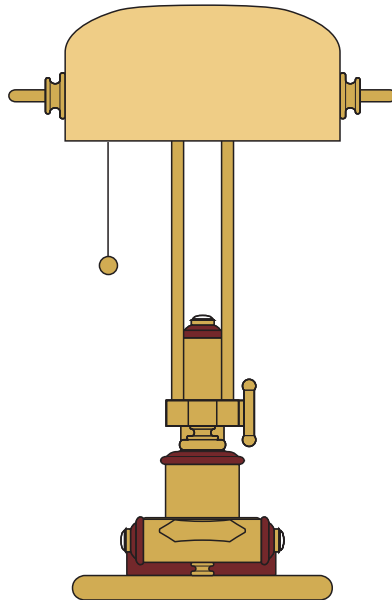

ART. 1513  
H. 570 - Larg. 310

CE IP 20 - E 27

Max Watt 52

20/23 Watt



LED bulb  
lampadina a LED

CLASSE EFFICIENZA  
ENERGETICA  
energy efficiency classes  
A+ ÷ E

Finitura ottone  
Finition laiton  
Brass finishes

**.A.V.A.R.BA.D**

Colore vetri / Couleurs verres / Glass colors / Gläs farbe

○ .6 = bianco/white    ● .7 = ambra/amber    ● .8 = verde/green



ART. 1513.D.7



ART. 1512.V.6



*Samoa*

# Figi

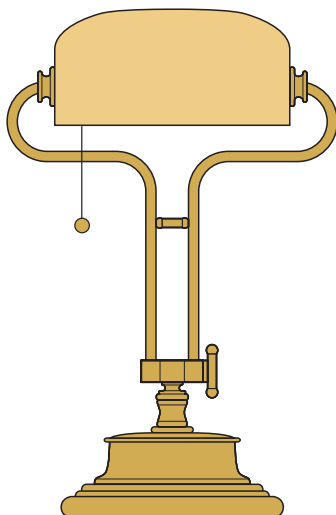

ART. 1509  
Base Ø 180  
H. 530 - Larg. 320

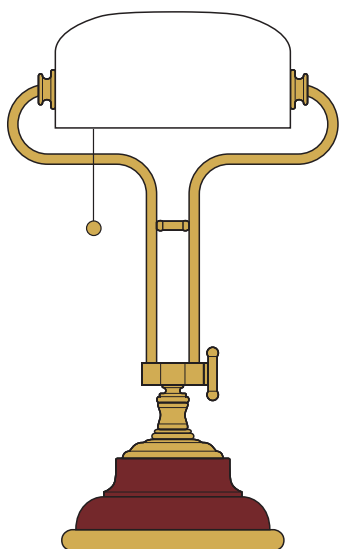

ART. 1511  
H. 530 - Larg. 320



CE IP 20 - E 27

Max Watt 52

20/23 Watt

LED bulb  
lampadina a LED

**CLASSE EFFICIENZA  
ENERGETICA**  
energy efficiency classes  
**A+ ÷ E**

Finitura ottone  
Finition laiton  
Brass finishes

**.A.V.A.R.B.A.D**

Colore vetri / Couleurs verres / Glass colors / Gläs farbe

○ .6 = bianco/white    ● .7 = ambra/amber    ● .8 = verde/green



Art. 1509.A.7



Art. 1511.D.6



Art. 1509.V.8

*Figi*



# Figi

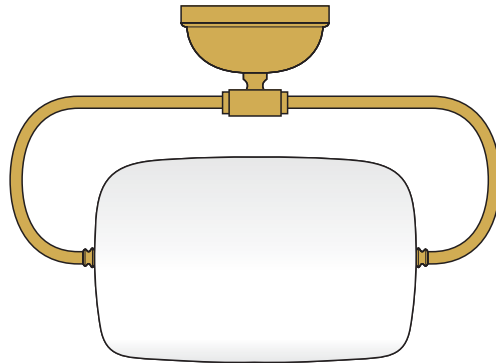

ART. 1500  
H. 160 - Larg. 320 - Prof. 200

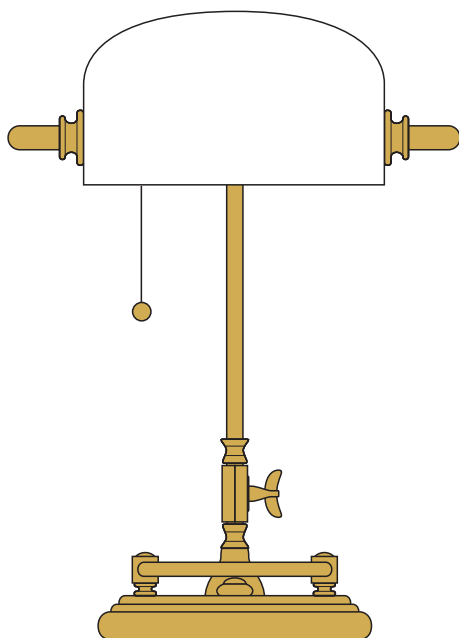

ART. 1503  
H. 490 - Larg. 320



CE IP 20 - E 27

Max Watt 52

20/23 Watt

LED bulb  
lampadina a LED

CLASSE EFFICIENZA  
ENERGETICA  
energy efficiency classes  
A+ ÷ E

Finitura ottone  
Finition laiton  
Brass finishes

**.A.V.AR.BA.D**

Colore vetri / Couleurs verres / Glass colors / Gläs farbe

○ .6 = bianco/white    ● .7 = ambra/amber    ● .8 = verde/green



Art. 1500.V.6

*Figi*



Art. 1503.D.8



Art. 1503.A.6

# Aphrodite

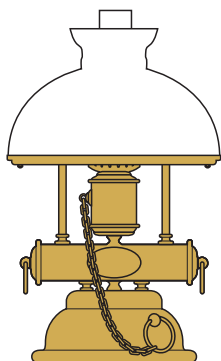

ART. 1440  
Vetro Ø 200  
H. 480 - Larg. 230

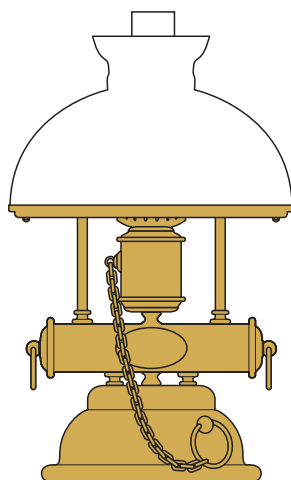

ART. 1441  
Vetro Ø 300  
H. 520 - Larg. 315

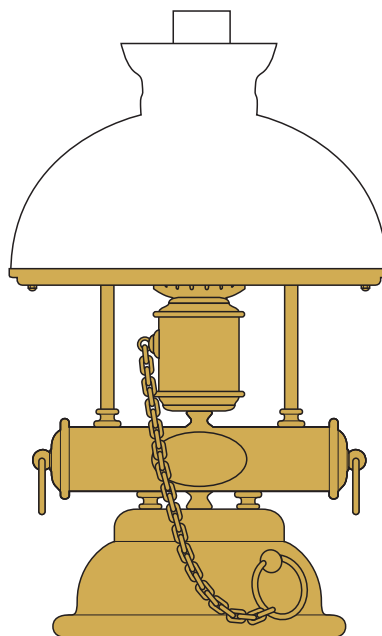

ART. 1442  
Vetro Ø 350  
H. 560 - Larg. 350

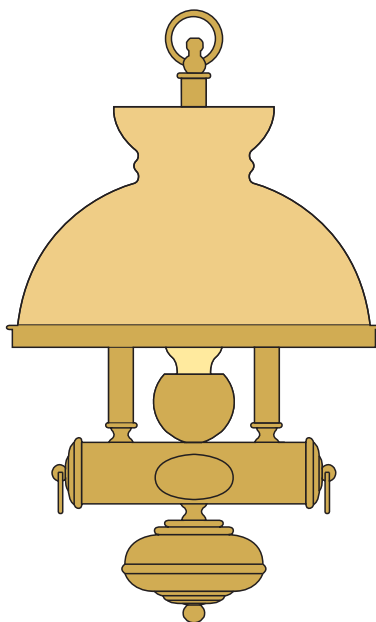

ART. 1444  
Vetro Ø 350 - H. 610

CE IP 20 - E 27

Max Watt 52

20/23 Watt

LED bulb  
lampadina a LED

CLASSE EFFICIENZA  
ENERGETICA  
energy efficiency classes  
A+ ÷ E

Finitura ottone  
Finition laiton  
Brass finishes

**.A.V.AR.BA.D**

Colore vetri / Couleurs verres / Glass colors / Gläs farbe

○ .6 = bianco/white    ● .7 = ambra/amber    ● .8 = verde/green



# *Aphrodite*



Art. 1441.A.6



Art. 1442.V.8



Art. 1444.V.6

# Aphrodite

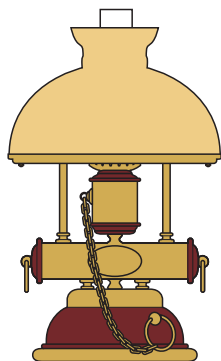

ART. 1448  
Vetro Ø 200  
H. 480 - Larg. 230

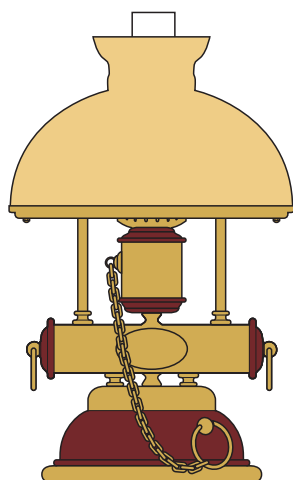

ART. 1449  
Vetro Ø 300  
H. 520 - Larg. 315

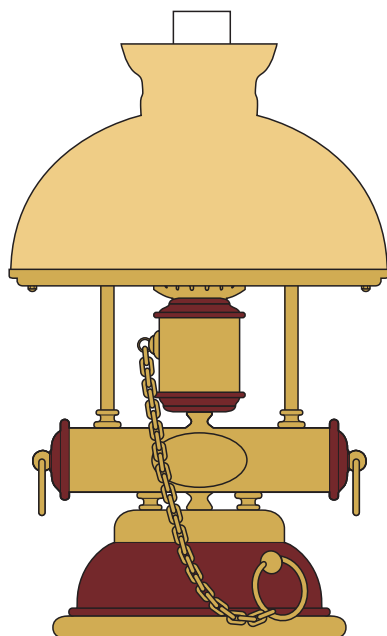

ART. 1453  
Vetro Ø 350  
H. 560 - Larg. 350

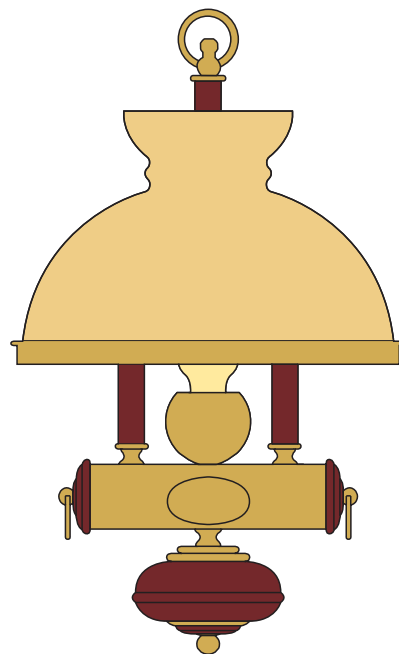

ART. 1452  
Vetro OP Ø 350 - H. 610



CE IP 20 - E 27

Max Watt 52

20/23 Watt

LED bulb  
lampadina a LED

CLASSE EFFICIENZA  
ENERGETICA  
energy efficiency classes  
A+ ÷ E

Finitura ottone  
Finition laiton  
Brass finishes

**.A.V.AR.BA.D**

Colore vetri / Couleurs verres / Glass colors / Gläs farbe

○ .6 = bianco/white    ● .7 = ambra/amber    ● .8 = verde/green



Art. 1453.A.7

*Aphrodite*



Art. 1452.V.7



# LEGENDA DEI SIMBOLI

## KEY TO SYMBOLS



Prodotto rispondente ai requisiti essenziali richiesti dalle Direttive europee in vigore.  
Product compliant with the essential requirements of the relative EU Directives in force.

---



Rifiuto di apparecchiatura elettrica - elettronica, deve essere smaltito in appositi contenitori.  
Waste Electrical and Electronic Equipment must be disposed of in differentiated waste containers.

---



Apparecchio che deve essere collegato al circuito di messa a terra dell'impianto per garantire la protezione alla scossa elettrica. - Equipment which must be connected to the system's earth circuit to guarantee protection against electric shock.

---



Apparecchio che non richiede il collegamento alla messa a terra dell'impianto in quanto la protezione alla scossa elettrica è garantita da un doppio isolamento con le parti in tensione.  
Equipment which does not need to be connected to the system's earth circuit as protection against electric shock is guaranteed by double insulation of live parts.

---



Apparecchio funzionante a bassissima tensione per la quale garantisce la protezione alla scossa elettrica. - Equipment which operates at low voltage which guarantees protection against electric shock.

---



Apparecchio non idoneo ad essere ricoperto da materiale isolante.  
Equipment not suitable for being covered with insulating material.

---

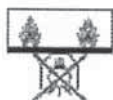

Apparecchio non idoneo ad essere installato su superfici normalmente infiammabili.  
Equipment not ideal for installation on normally flammable surfaces.

---



Vetro di protezione che se danneggiato deve essere obbligatoriamente sostituito.  
Protective glass which **MUST** be replaced if damaged.

---

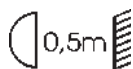

Distanza da mantenere fra l'apparecchio e la superficie illuminata.  
Clearance between the appliance and the illuminated surface.

---

# GRADO DI PROTEZIONI DEGLI APPARECCHI

## APPLIANCE PROTECTION RATINGS

<b>IP 20</b>	Apparecchio ordinario - Ordinary appliance
<b>IP X1</b>	Apparecchio protetto allo stillicidio - Appliance protected against vertically falling drops of water
<b>IP X3</b>	Apparecchio protetto contro la pioggia - Appliance protected against rain
<b>IP X4</b>	Apparecchio protetto agli spruzzi d'acqua - Appliance protected against water spray
<b>IP X5</b>	Apparecchio protetto ai getti d'acqua - Appliance protected against low pressure water jets
<b>IP X6</b>	Apparecchio protetto contro i getti d'acqua potenti Appliance protected against high pressure water jets
<b>IP X7</b>	Apparecchio stagno all'immersione Appliance protected against the effects of temporary immersion
<b>IP X8 m</b>	Apparecchio stagno alla sommersione (seguito dall'indicazione della massima profondità di immersione in metri) - Appliance protected against the effects of continuous immersion (followed by an indication of the maximum immersion depth in metres)
<b>IP 3X</b>	Apparecchio a prova di penetrazione di corpi solidi di diametro superiore a 2,5 mm Appliance protected against solid objects with a diameter over 2.5 mm
<b>IP 4X</b>	Apparecchio a prova di penetrazione di corpi solidi di diametro superiore a 1 mm Appliance protected against solid objects with a diameter over 1 mm
<b>IP 5X</b>	Apparecchio protetto contro la polvere - Appliance protected from limited dust ingress
<b>IP 6X</b>	Apparecchio totalmente protetto contro la polvere Appliance protected against total dust ingress

Si consiglia l'utilizzo di sole lampadine di qualità (Philips - Osram - Sylvania - Beghelli). La società non risponde di eventuali danni o problemi emersi per l'utilizzo di lampadine non conformi o non certificate.

We recommend the use of quality light bulbs only (Philips - Osram - Sylvania - Beghelli). The company shall not be held liable for any damages or problems arising from the use of non-compliant or non-certified light bulbs.

# Vetri

COLORI VETRI: Bianco - Ambra - Verde - Blu / COULEURS DES OPALINES: Blanc - Paille - Vert - Bleu  
 GLASS COLOURS: White - Amber - Green - Blue / GLÄS FARBE: Weiss - Bernstein - Grün - Blau

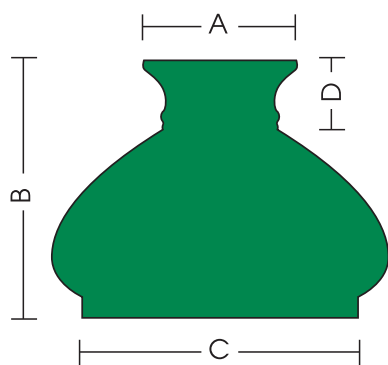

	A	B	C	D
ART. V1	- 95	- 126	- 120	- 40
ART. V2	- 100	- 154	- 135	- 58
ART. V3	- 116	- 191	- 193	- 67

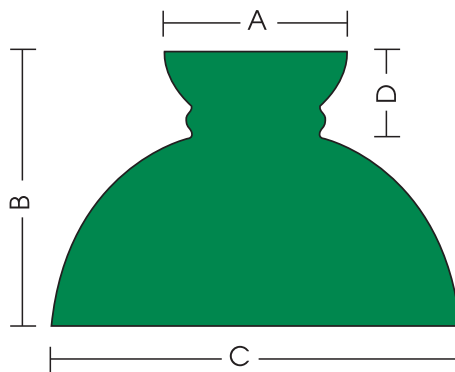

	A	B	C	D
ART. V5	- 138	- 214	- 294	- 65
ART. V6	- 152	- 230	- 345	- 74

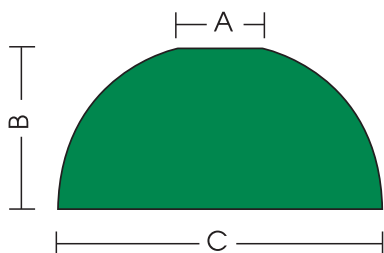

	A	B	C
ART. V8	- 44	- 53	- 118
ART. V9	- 44	- 73	- 142
ART. V10	- 44	- 97	- 193
ART. V11	- 82	- 115	- 242
ART. V12	- 89	- 142	- 298
ART. V13	- 97	- 167	- 344
ART. V14	- 103	- 187	- 393



ART. V11C	- Ø 25
ART. V12C	- Ø 30
ART. V13C	- Ø 35
ART. V14C	- Ø 40

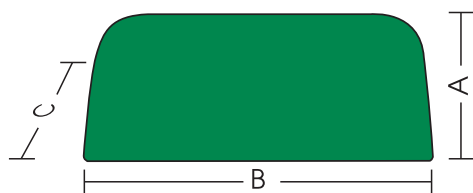

	A	B	C	Prof.
ART. V26	- 75	- 155	- 95	
ART. V27	- 95	- 230	- 150	

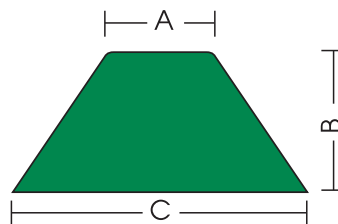

	A	B	C
ART. V28	- 52	- 94	- 190
ART. V29	- 44	- 114	- 245



**CHIARIMENTI:** L'Antichizzazione è fatta manualmente e la tonalità dell'ottone può avere sfumature diverse da quelle delle foto. L'Antichizzazione fatta a mano non impedisce la naturale ossidazione di questo metallo che, esposto all'esterno, è soggetto all'azione degli eventi naturali. I nostri prodotti non sono autopulenti quindi, se vengono ricoperti da salsedine, devono essere puliti con i normali prodotti per pulizia dei metalli. Svolta la procedura di pulitura, pian piano nel tempo riprodurranno la patina tipica dell'invecchiamento dell'ottone.

**.V** - Ottone lucido  
con vernice protettiva trasparente  
colore adatto solo per intern  
Polished brass with transparent protector  
only for indoor light  
Laiton verni seulement pour mettre  
dedans les maison:



**.D** - Ottone bagno oro 24 Kt  
Laiton doré 24 carats  
Brass 24 Kt gold - dipped

**Esempio - Example**

**Art. 1506.V** = ottone lucido  
laiton verni - polished brass

**Art. 1506.A** = ottone brunito antichizzato  
laiton vieilli - brass burnish finishing

## Colore vetri

Couleurs des opalines - Glass colors - Gläs farbe



**.6** - Bianco  
- Blanc - White - Weiss



**.7** - Ambra  
- Paille - Amber - Bernstein



**.8** - Verde  
- Vert - Green - Grün

**Esempio - Example**

**Art. 1924.A.8** = ottone brunito antichizzato con vetro verde  
laiton vieilli avec opaline vert  
brass burnish finishing with green glass



Russia - Baltic Sea





Russia - Baltic Sea







 Moretti Luce

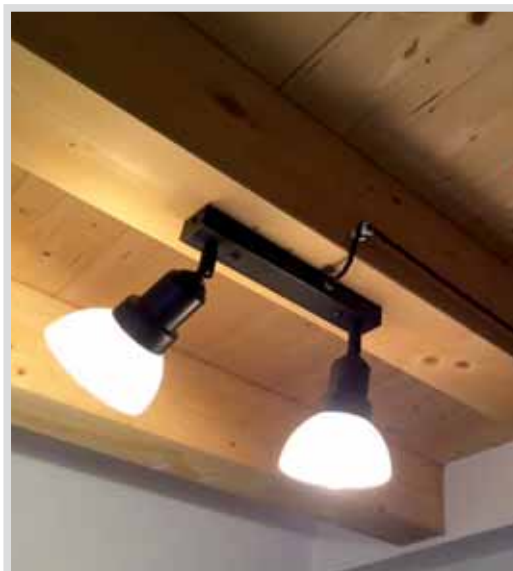

 Moretti Luce



Moretti Luce



MORETTI LUCE Srl  
Via Divisione Acqui 14/16  
25065 Lumezzane S. Sebastiano Z.I. (BS)  
Tel. +39 030 82.04.728  
Fax +39 030 82.04.729

[info@morettiluce.it](mailto:info@morettiluce.it)  
[www.morettiluce.com](http://www.morettiluce.com)